

LIMA 4.7, Lisens: Plankontoret Hallvard Homme AS, Parsell: Parsell1.ps1

Rauland Invest AS Holtarvegen Tverrprofil	Tegnet av AST	Saksbehandler
	Sidemannskontr.	Prosjektansvarlig AST
Plankontoret H. Homme AS 4747 Valle Tlf: 37 93 70 00, Fax: 37 93 74 74, E-Post: post@plankontoret.no	Dato 03.12.2009	Målestokk 1: 200
	Prosj.nr. 2219-v1	1: 200
	Tegn.nr. -Tp-1	Rev.

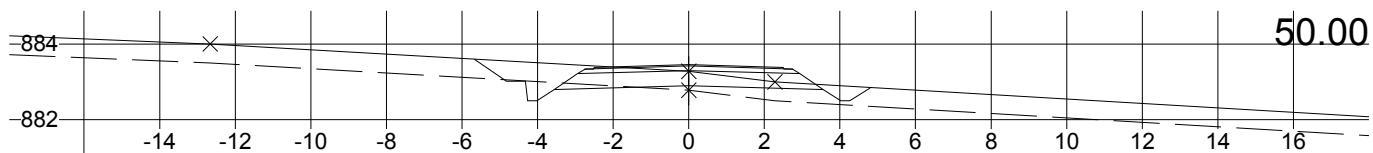
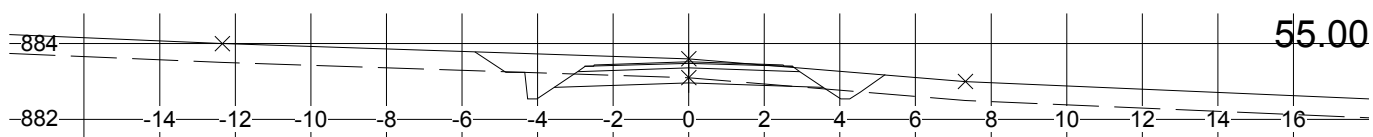
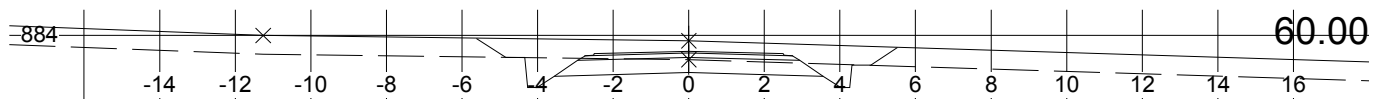
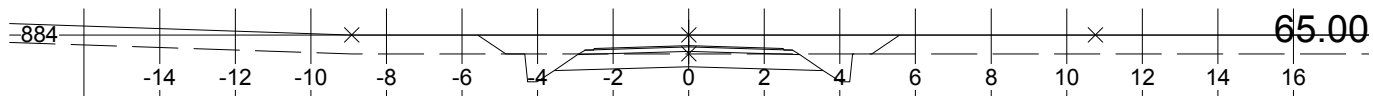
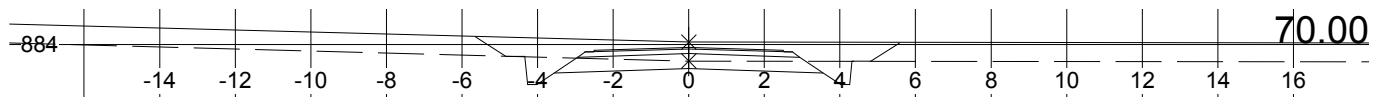
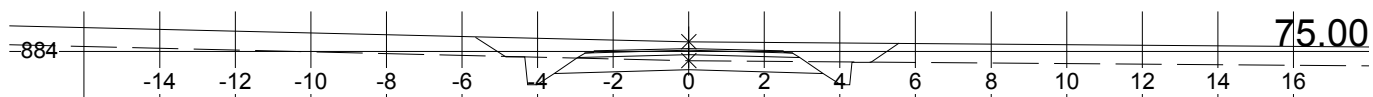
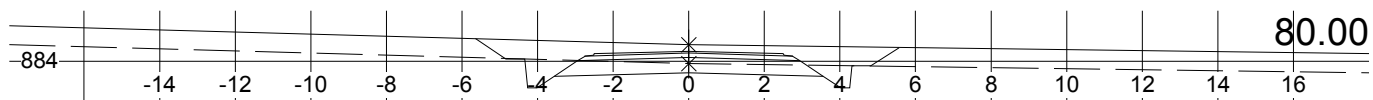
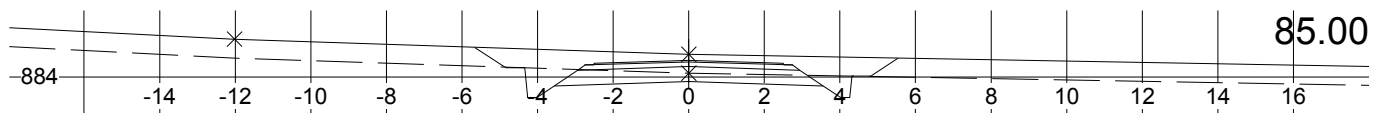
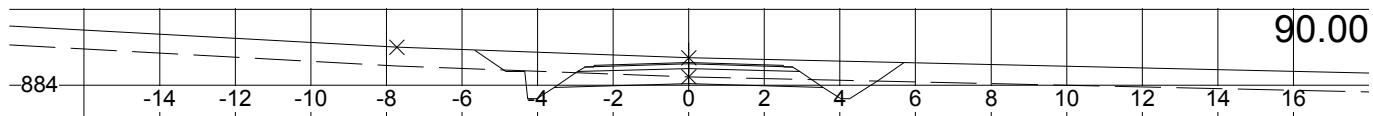

L:\IMA 4.7, Lisens: Plankontoret Hallvard Homme AS, Parsell: Parsell1.ps1

Rauland Invest AS Holtarvegen Tverrprofil	Tegnet av AST	Saksbehandler
	Sidemannskontr.	Prosjektansvarlig AST
Plankontoret H. Homme AS 4747 Valle Tlf: 37 93 70 00, Fax: 37 93 74 74, E-Post: post@plankontoret.no	Dato 03.12.2009	Målestokk 1: 200 1: 200
	Prosj.nr. 2219-v1	
	Tegn.nr. -Tp-2	Rev.

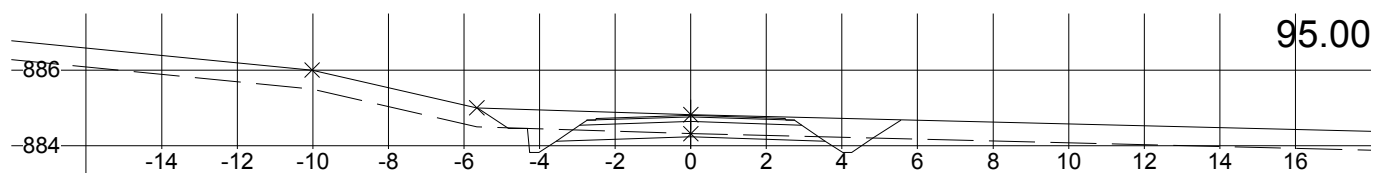
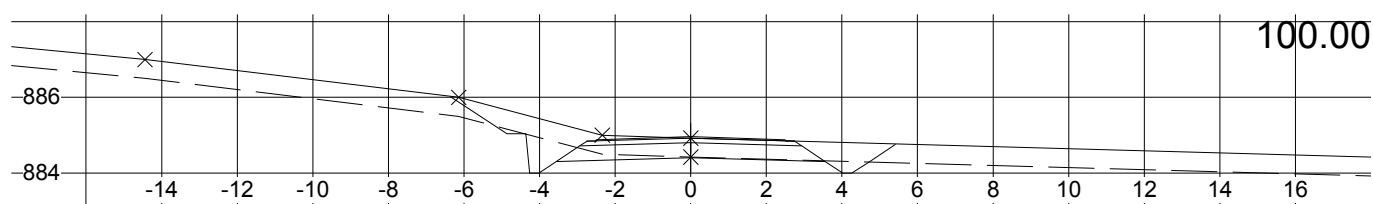
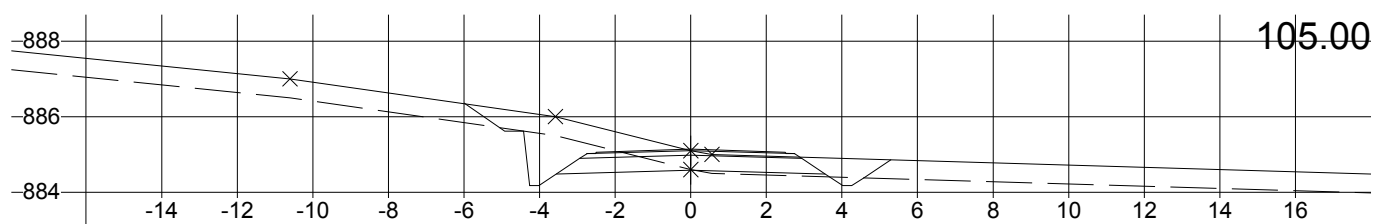
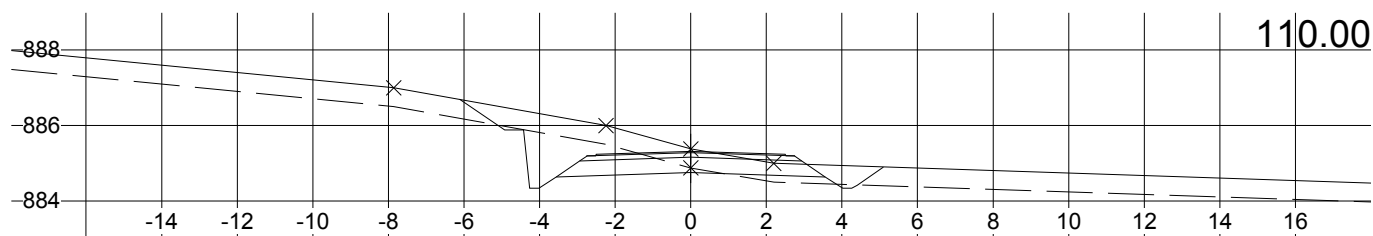
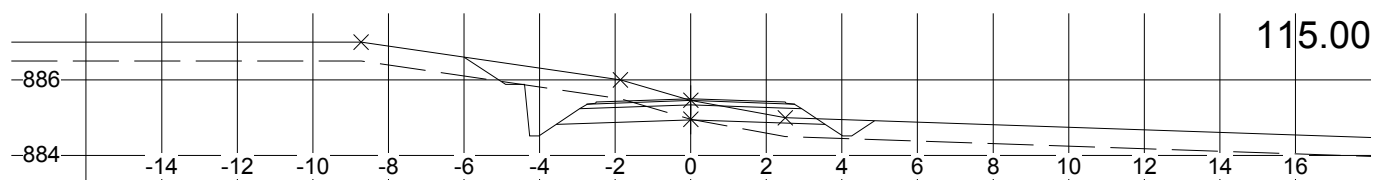
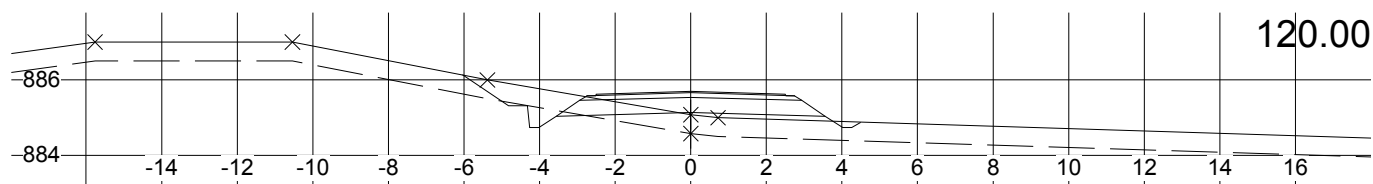

L:\IMA 4.7, Lisens: Plankontoret Hallvard Homme AS, Parsell: Parsell1.psl

Rauland Invest AS Holtarvegen Tverrprofil	Tegnet av AST	Saksbehandler
	Sidemannskontr.	Prosjektansvarlig AST
Plankontoret H. Homme AS 4747 Valle Tlf: 37 93 70 00, Fax: 37 93 74 74, E-Post: post@plankontoret.no	Dato 03.12.2009	Målestokk 1: 200
	Prosj.nr. 2219-v1	1: 200
	Tegn.nr. -Tp-3	Rev.

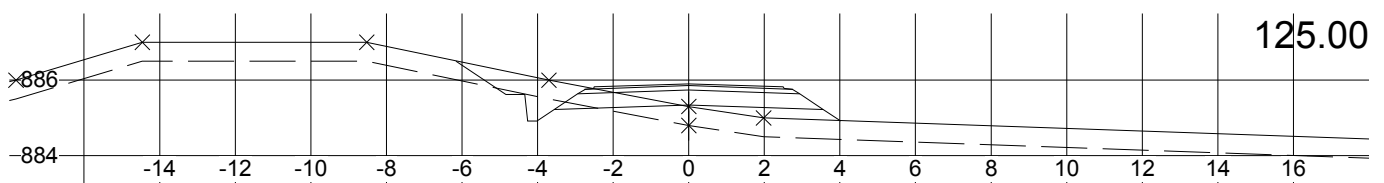
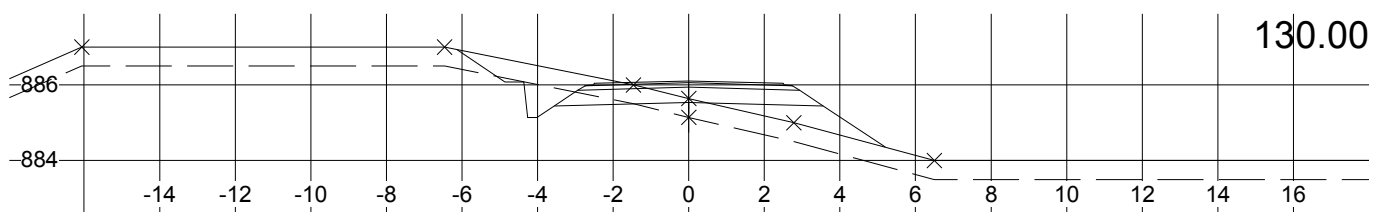
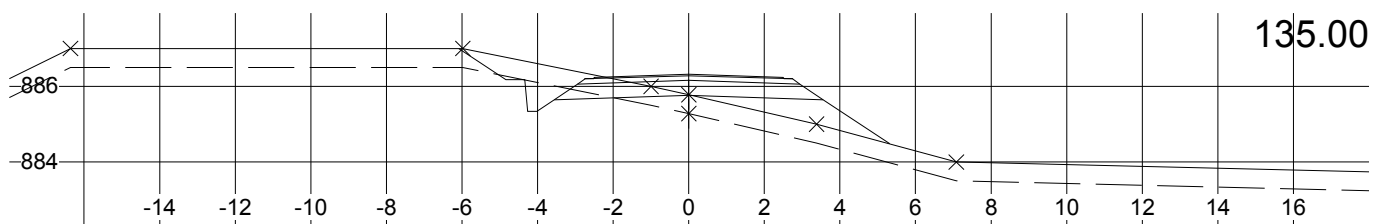
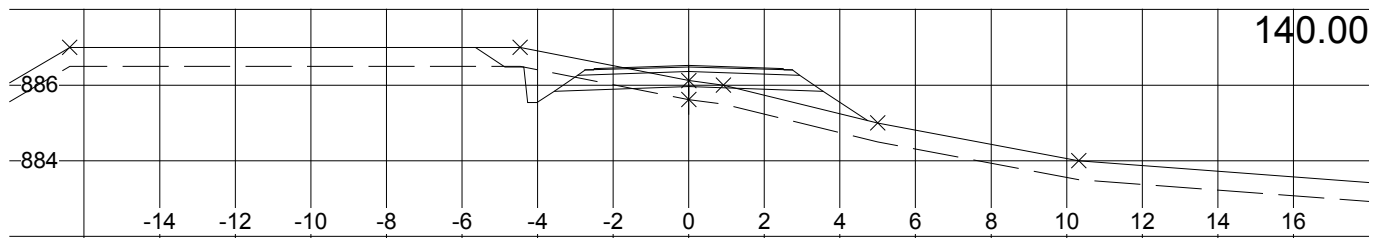
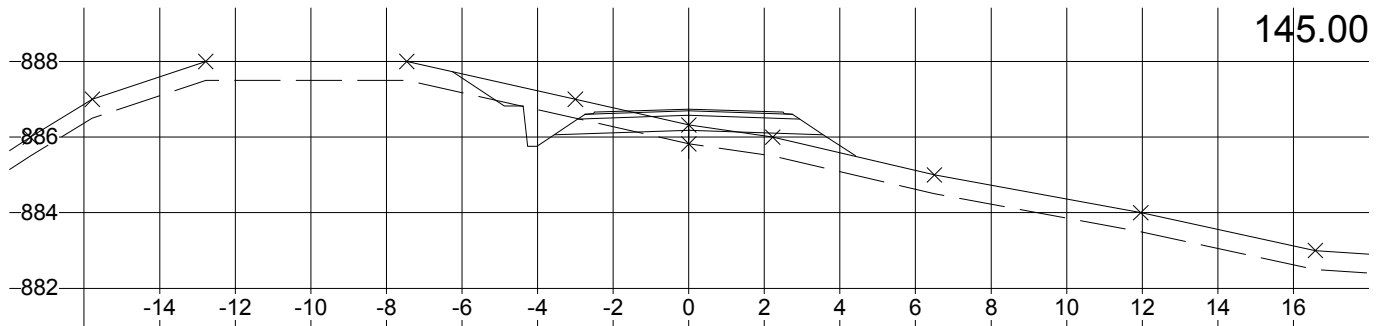

L:\IMA 4.7, Lisens: Plankontoret Hallvard Homme AS, Parsell: Parsell1.psl

Rauland Invest AS Holtarvegen Tverrprofil	Tegnet av AST	Saksbehandler
	Sidemannskontr.	Prosjektansvarlig AST
Plankontoret H. Homme AS 4747 Valle Tlf: 37 93 70 00, Fax: 37 93 74 74, E-Post: post@plankontoret.no	Dato 03.12.2009	Målestokk 1: 200
	Prosj.nr. 2219-v1	1: 200
	Tegn.nr. -Tp-4	Rev.

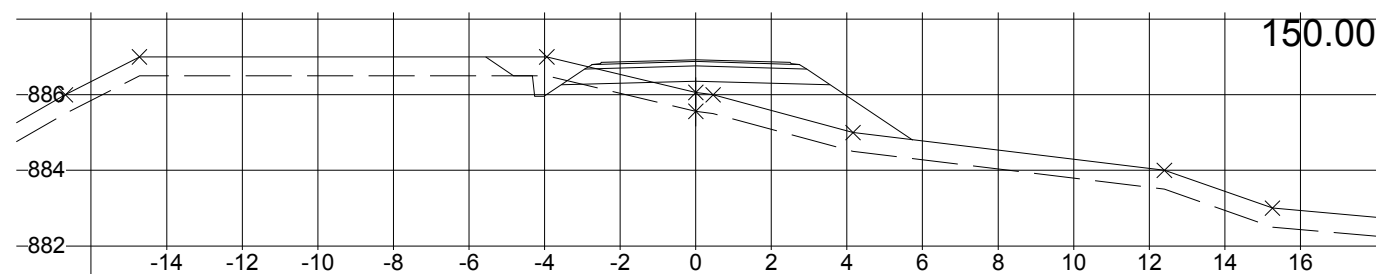
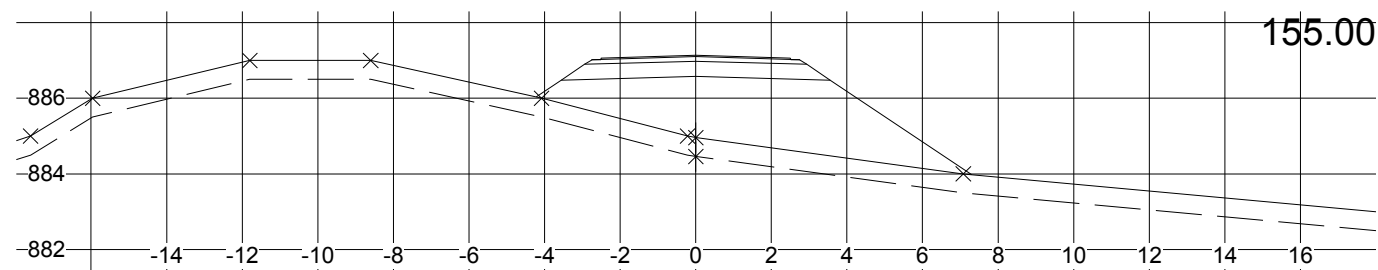
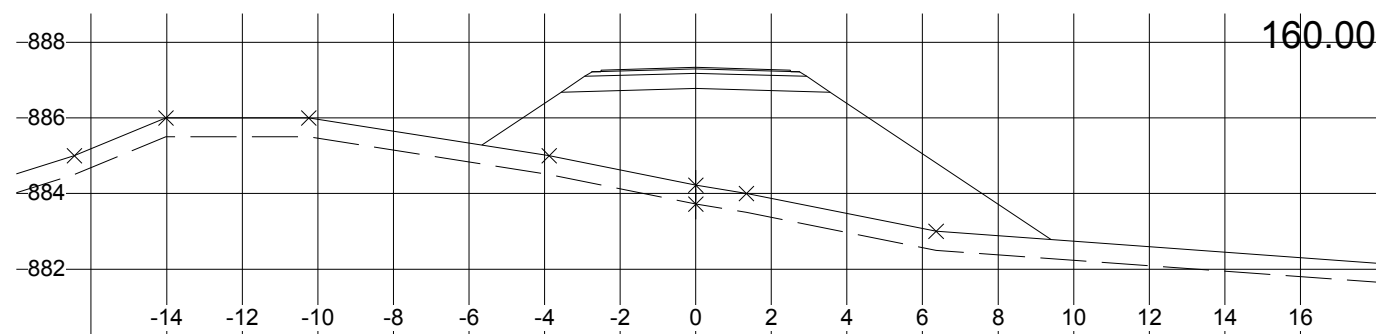
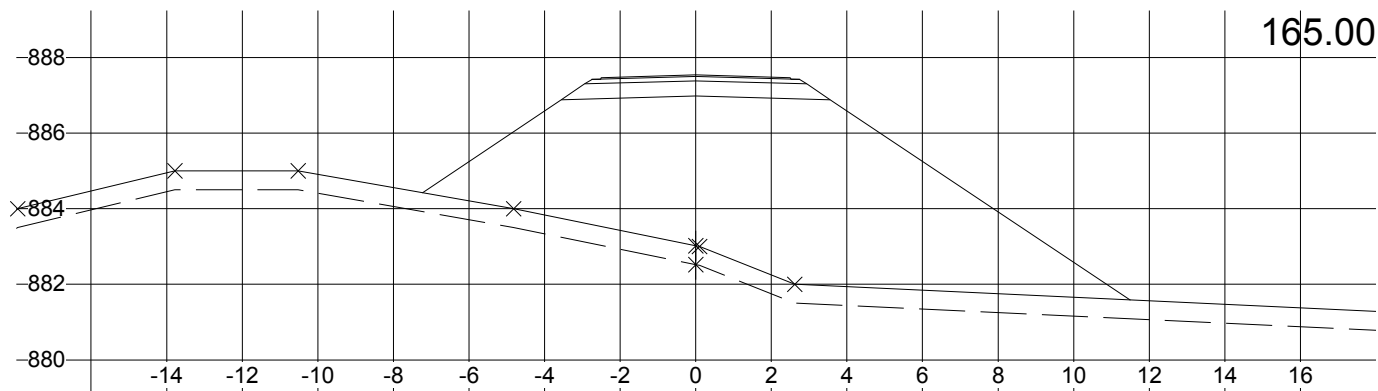

L:\IMA 4.7, Lisens: Plankontoret Hallvard Homme AS, Parsell: Parsell1.psl

Rauland Invest AS Holtarvegen Tverrprofil	Tegnet av AST	Saksbehandler
	Sidemannskonstr.	Prosjektansvarlig AST
	Dato 03.12.2009	Målestokk 1: 200 1: 200
	Prosj.nr. 2219-v1	Rev.
Plankontoret H. Homme AS 4747 Valle Tlf: 37 93 70 00, Fax: 37 93 74 74, E-Post: post@plankontoret.no	Tegn.nr. -Tp-5	

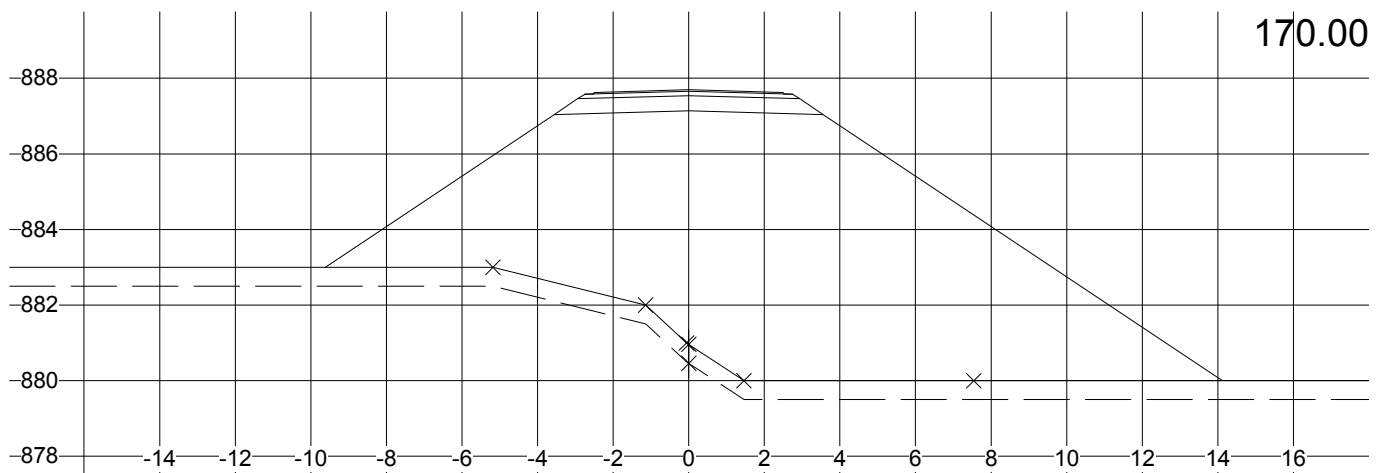
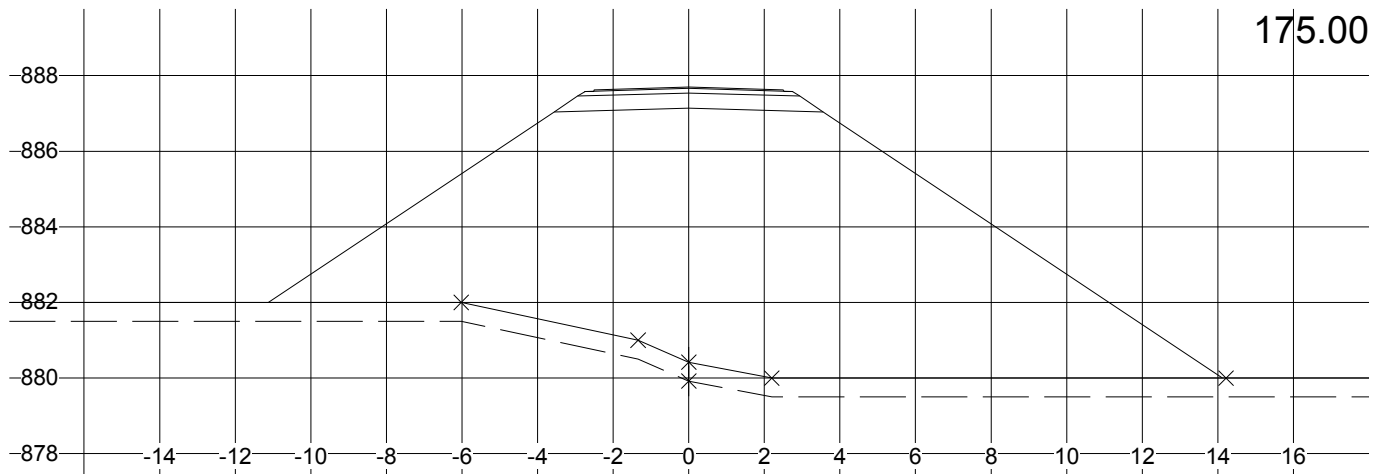
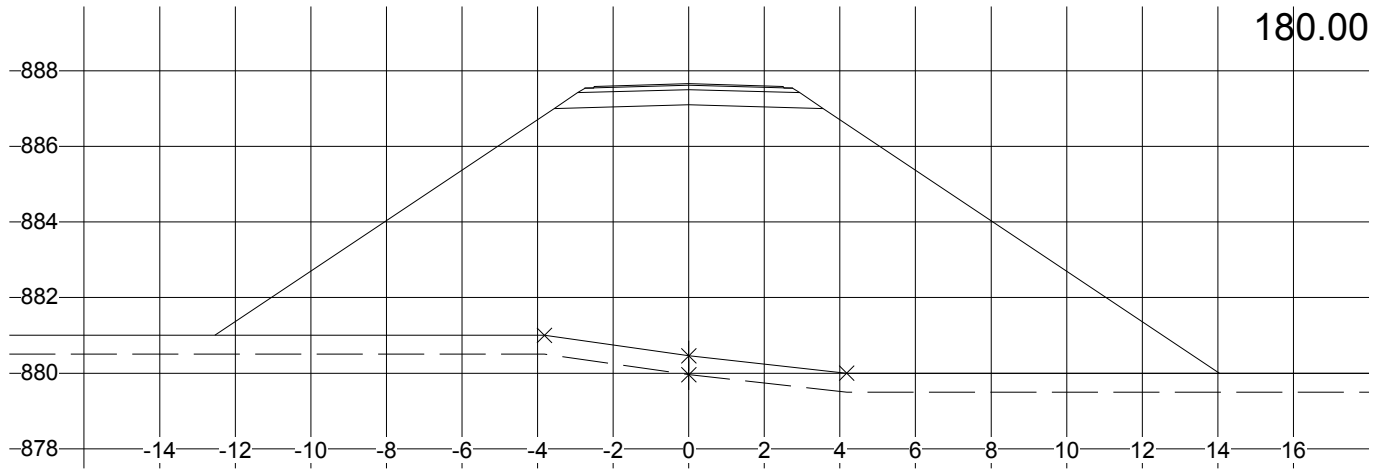

Rauland Invest AS Holtarvegen Tverrprofil	Tegnet av AST	Saksbehandler
	Sidemannskontr.	Prosjektansvarlig AST
Plankontoret H. Homme AS 4747 Valle Tlf: 37 93 70 00, Fax: 37 93 74 74, E-Post: post@plankontoret.no	Dato 03.12.2009	Målestokk 1: 200
	Prosj.nr. 2219-v1	1: 200
	Tegn.nr. -Tp-6	Rev.

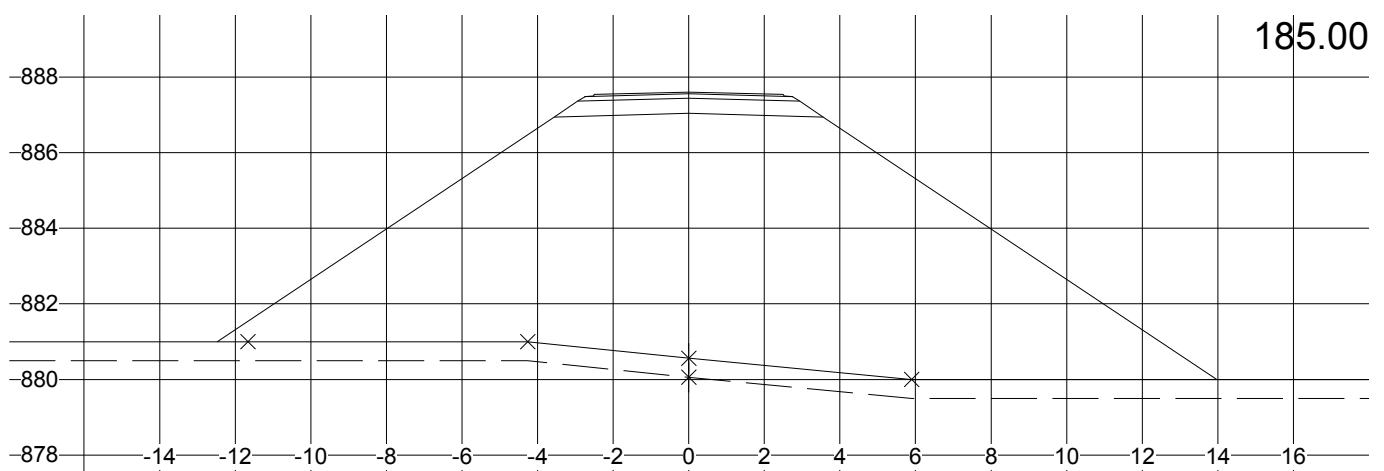
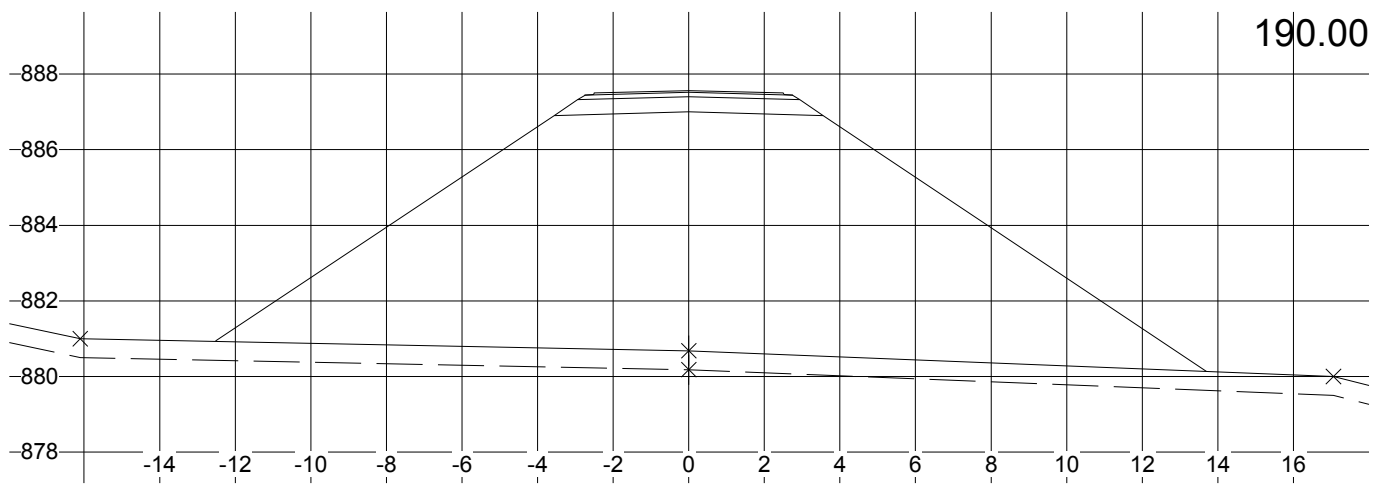
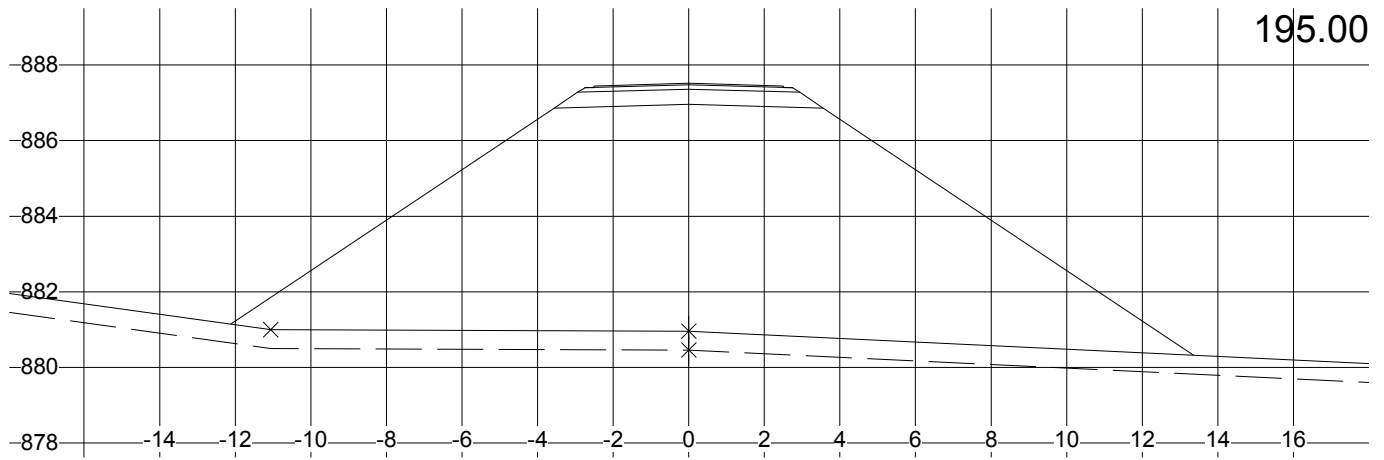

LIMA 4.7, Lisens: Plankontoret Hallvard Homme AS, Parsell: Parsell1.psl

Rauland Invest AS Holtarvegen Tverrprofil	Tegnet av AST	Saksbehandler
	Sidemannskonstr.	Prosjektansvarlig AST
	Dato 03.12.2009	Målestokk 1: 200 1: 200
	Prosj.nr. 2219-v1	Rev.
Plankontoret H. Homme AS 4747 Valle Tlf: 37 93 70 00, Fax: 37 93 74 74, E-Post: post@plankontoret.no	Tegn.nr. -Tp-7	

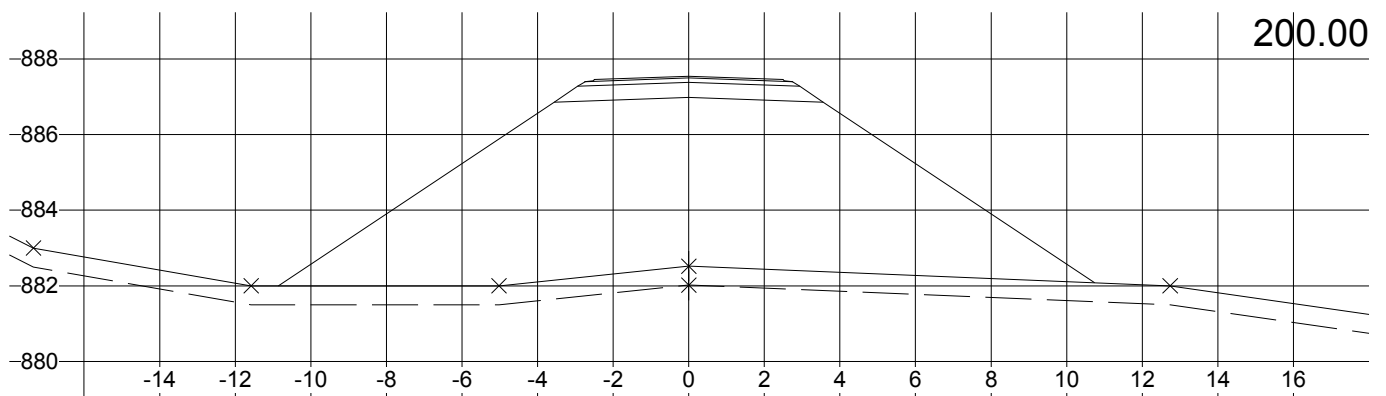
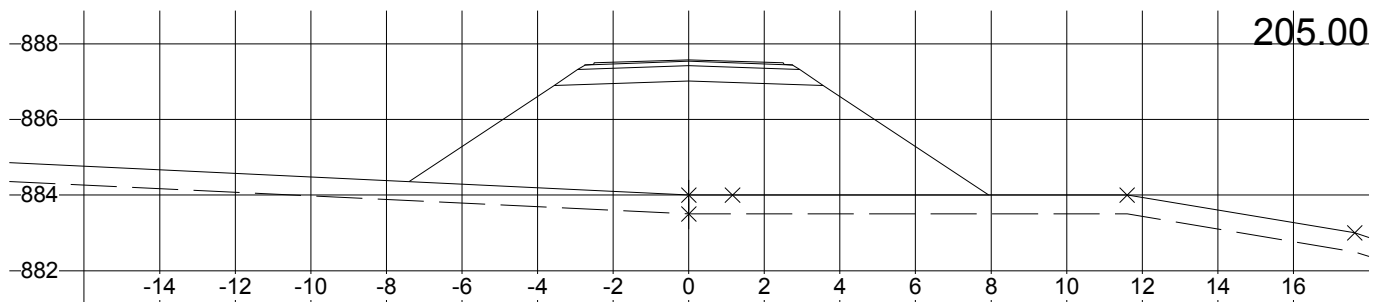
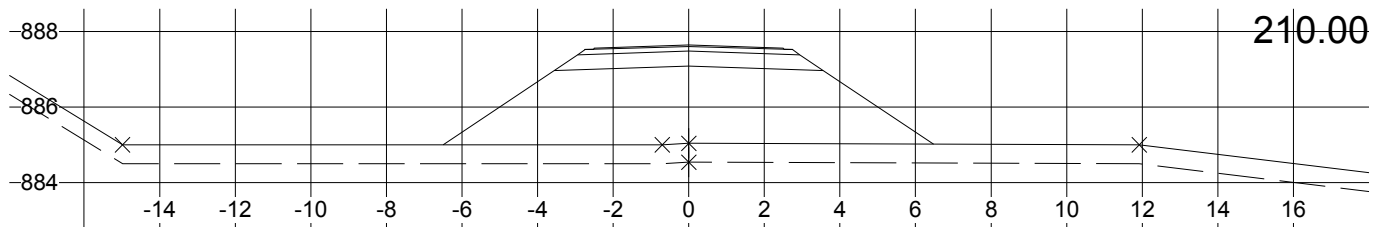
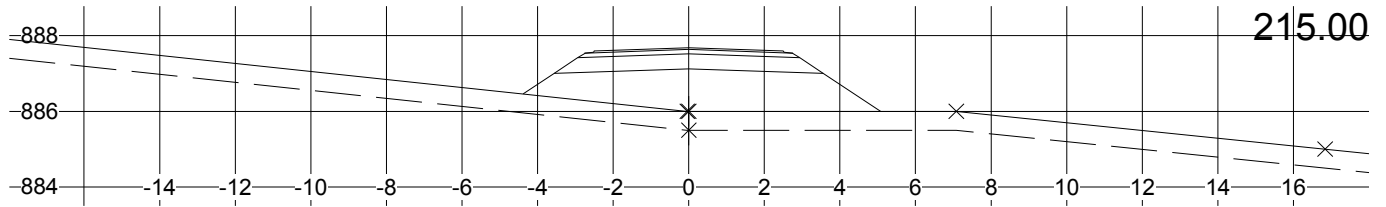
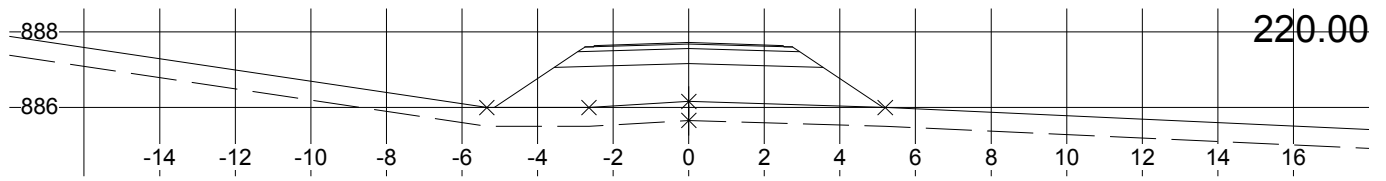

L:\IMA 4.7, Lisens: Plankontoret Hallvard Homme AS, Parsell: Parsell1.ps1

Rauland Invest AS Holtarvegen Tverrprofil	Tegnet av AST	Saksbehandler
	Sidemannskonstr.	Prosjektansvarlig AST
Plankontoret H. Homme AS 4747 Valle Tlf: 37 93 70 00, Fax: 37 93 74 74, E-Post: post@plankontoret.no	Dato 03.12.2009	Målestokk 1: 200
	Prosj.nr. 2219-v1	1: 200
	Tegn.nr. -Tp-8	Rev.

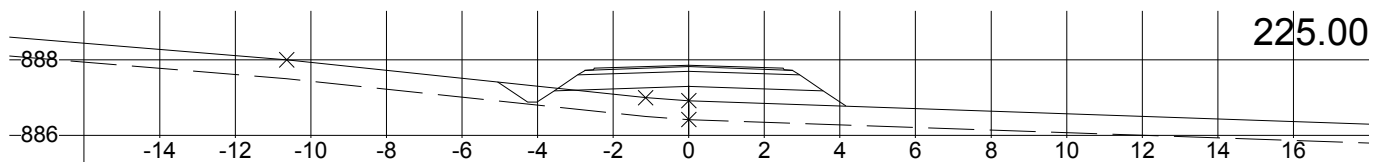
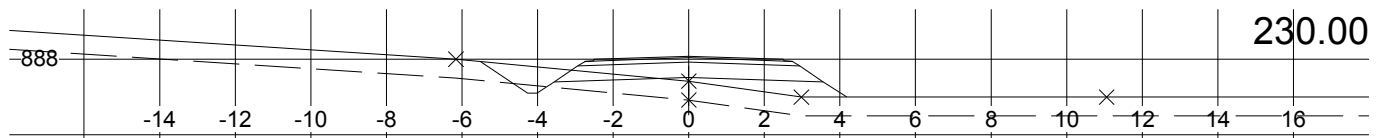
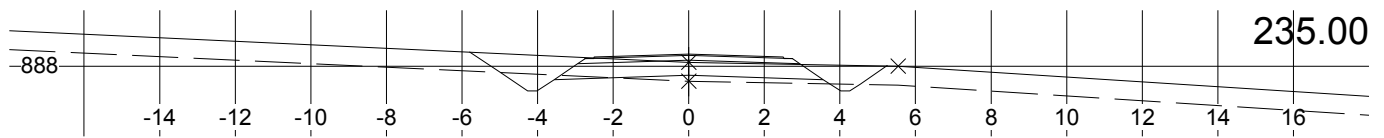
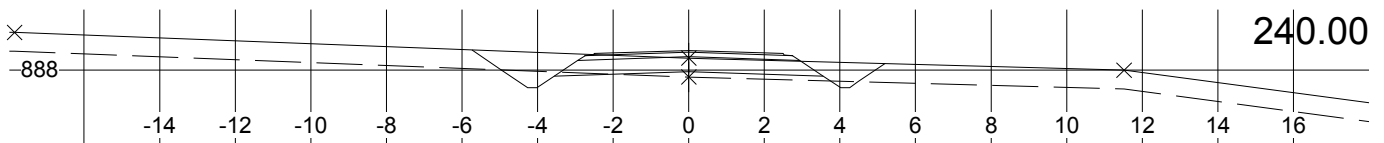
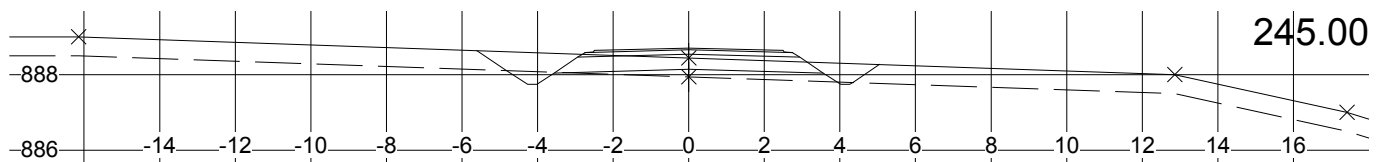
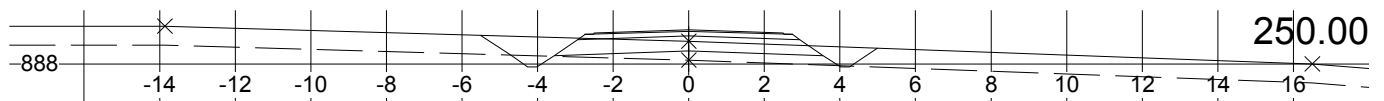
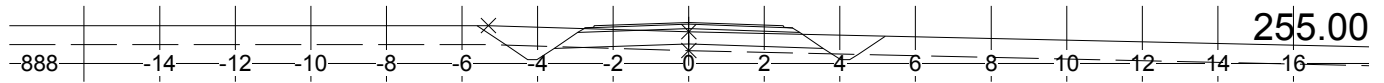
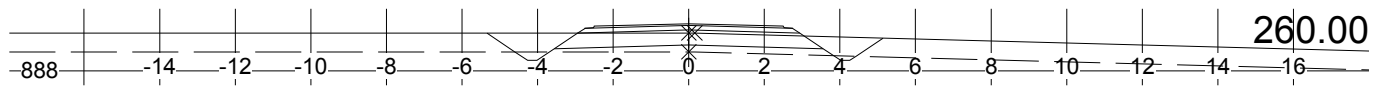
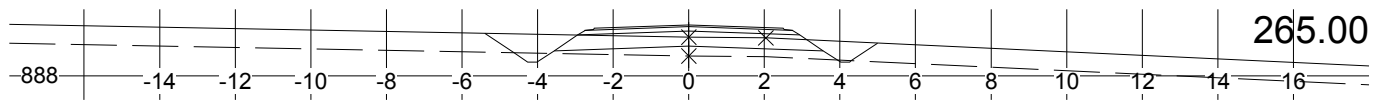

L:\IMA 4.7, Lisens: Plankontoret Hallvard Homme AS, Parsell: Parsell1.psl

Rauland Invest AS Holtarvegen Tverrprofil	Tegnet av AST	Saksbehandler
	Sidemannskontr.	Prosjektansvarlig AST
Plankontoret H. Homme AS 4747 Valle Tlf: 37 93 70 00, Fax: 37 93 74 74, E-Post: post@plankontoret.no	Dato 03.12.2009	Målestokk 1: 200 1: 200
	Prosj.nr. 2219-v1	
	Tegn.nr. -Tp-9	Rev.

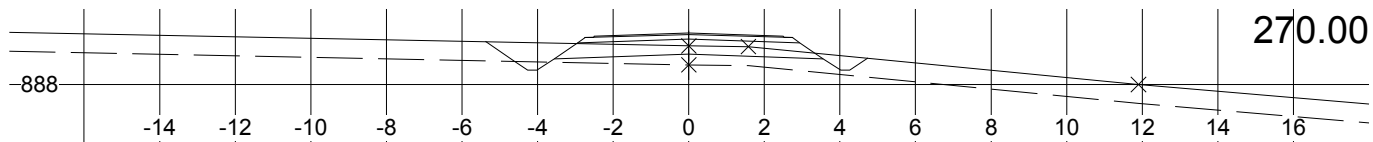
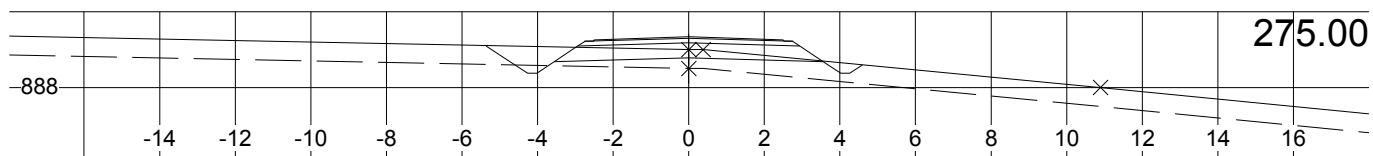
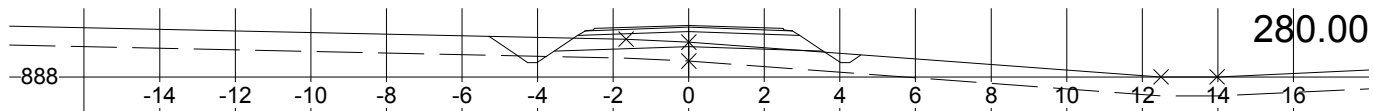
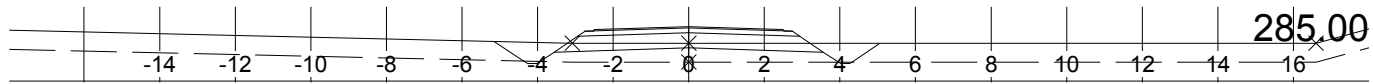
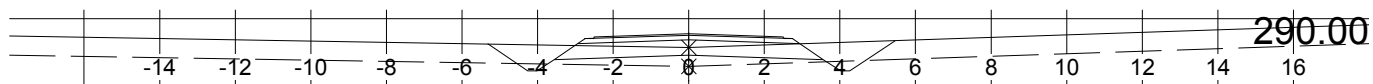
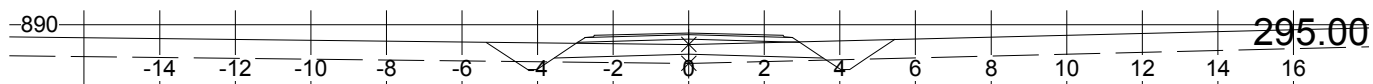
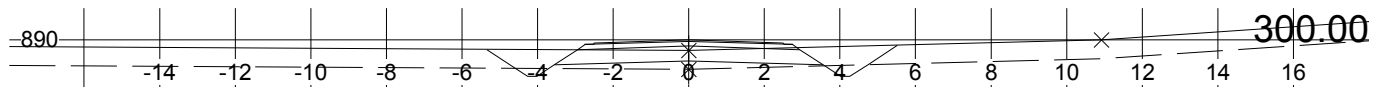
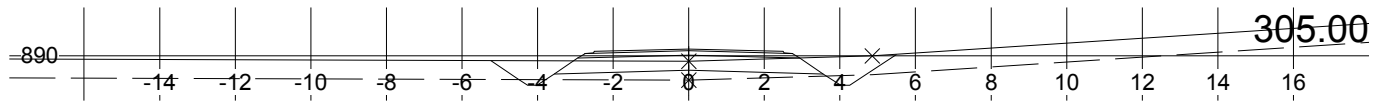
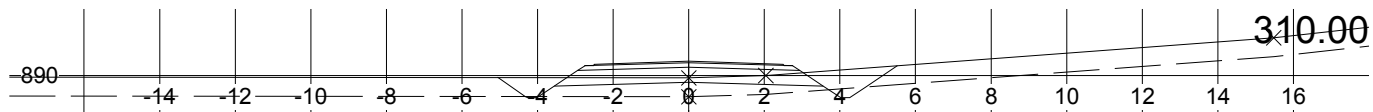
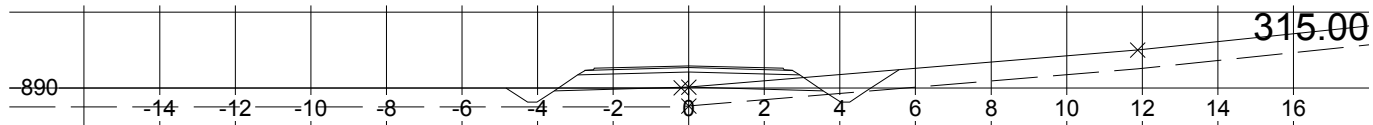

LIMA 4.7, Lisens: Plankontoret Hallvard Homme AS, Parsell: Parsell1.psl

Rauland Invest AS Holtarvegen Tverrprofil	Tegnet av AST	Saksbehandler
	Sidemannskontr.	Prosjektansvarlig AST
Plankontoret H. Homme AS 4747 Valle Tlf: 37 93 70 00, Fax: 37 93 74 74, E-Post: post@plankontoret.no	Dato 03.12.2009	Målestokk 1: 200
	Prosj.nr. 2219-v1	1: 200
	Tegn.nr. -Tp-10	Rev.

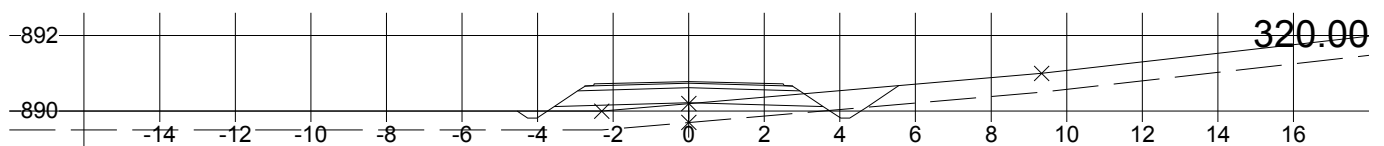
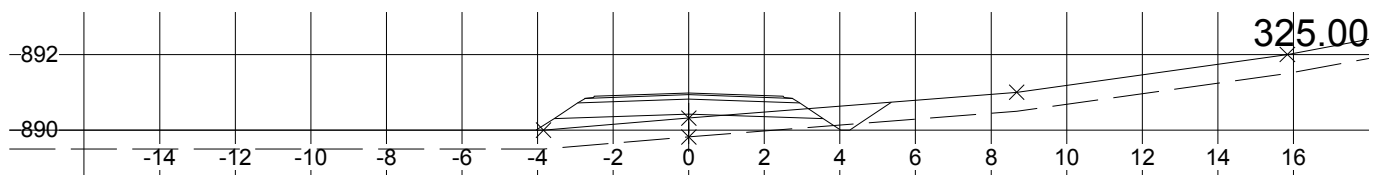
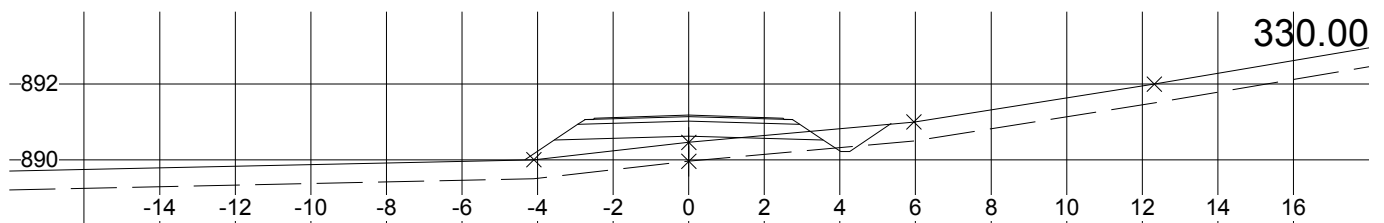
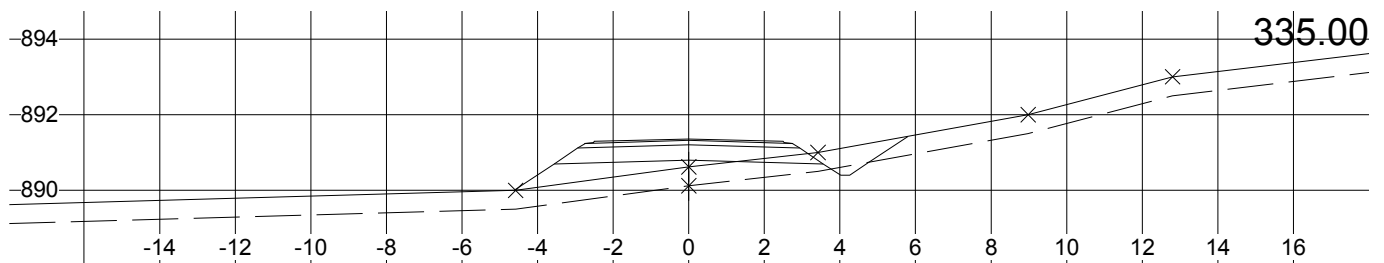
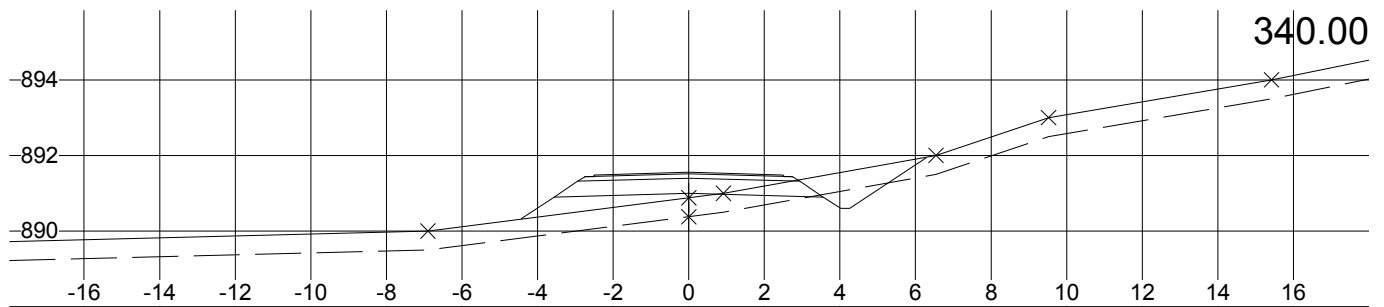

LIMA 4.7, Lisens: Plankontoret Hallvard Homme AS, Parsell: Parsell1.psl

Rauland Invest AS Holtarvegen Tverrprofil	Tegnet av AST	Saksbehandler
	Sidemannskontr.	Prosjektansvarlig AST
	Dato 03.12.2009	Målestokk 1: 200 1: 200
	Prosj.nr. 2219-v1	Rev.
Plankontoret H. Homme AS 4747 Valle Tlf: 37 93 70 00, Fax: 37 93 74 74, E-Post: post@plankontoret.no	Tegn.nr. -Tp-11	

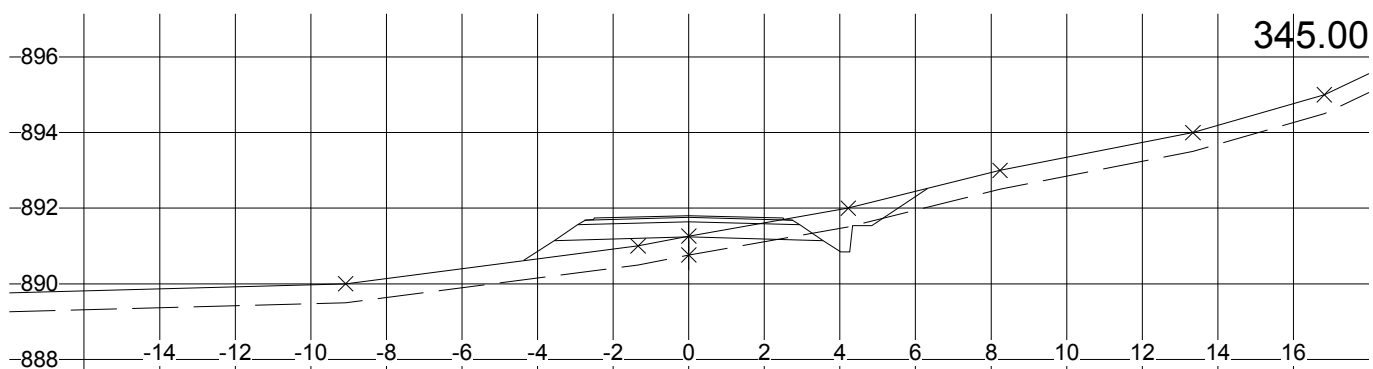
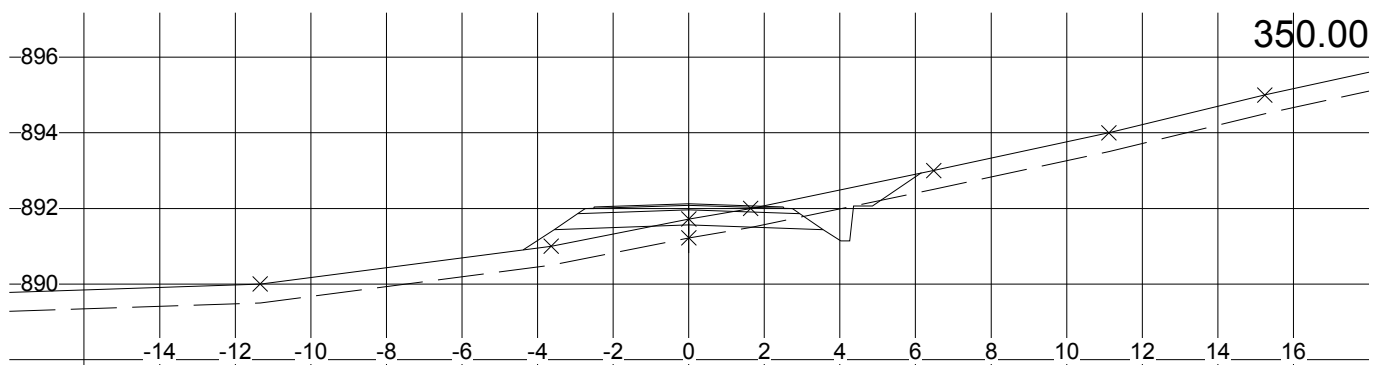
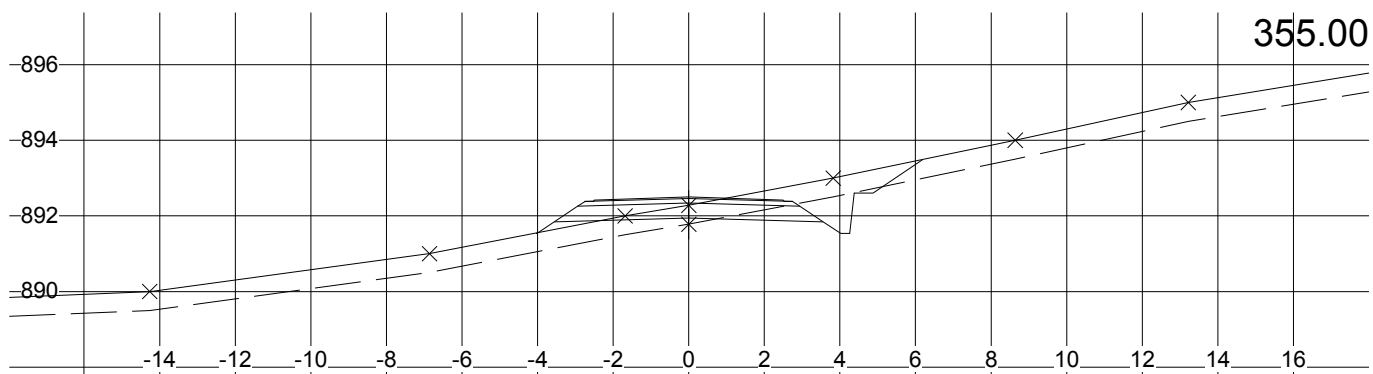
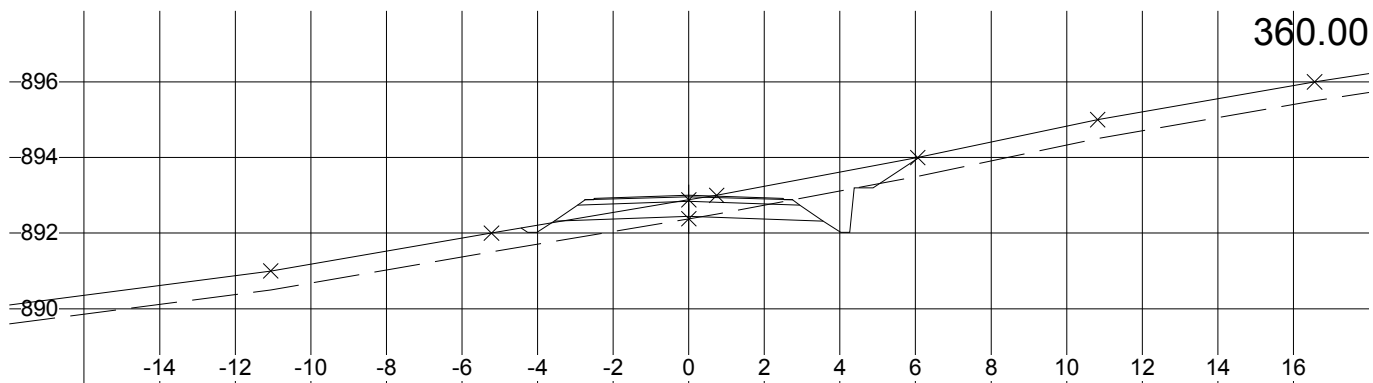

L:\IMA 4.7, Lisens: Plankontoret Hallvard Homme AS, Parsell: Parsell1.ps1

Rauland Invest AS Holtarvegen Tverrprofil	Tegnet av AST	Saksbehandler
	Sidemannskonstr.	Prosjektansvarlig AST
Plankontoret H. Homme AS 4747 Valle Tlf: 37 93 70 00, Fax: 37 93 74 74, E-Post: post@plankontoret.no	Dato 03.12.2009	Målestokk 1: 200
	Prosj.nr. 2219-v1	1: 200
	Tegn.nr. -Tp-12	Rev.

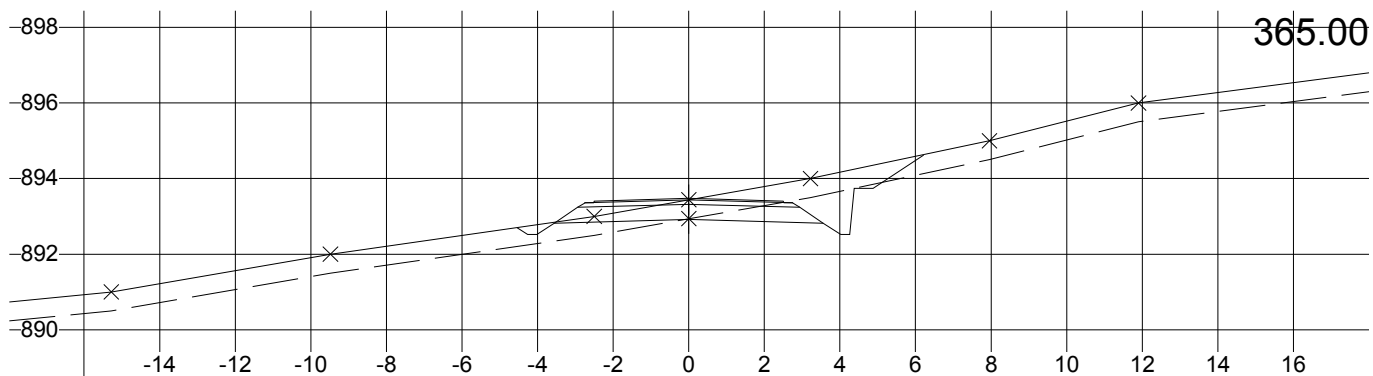
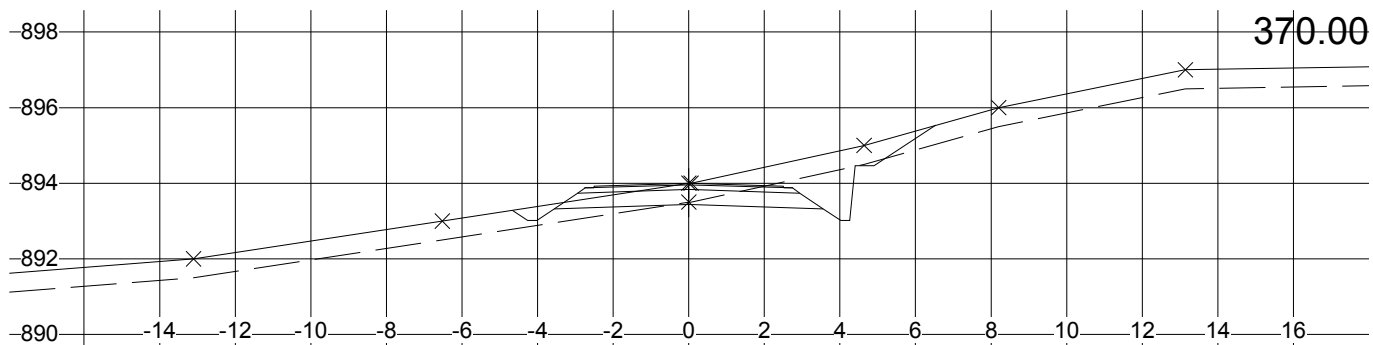
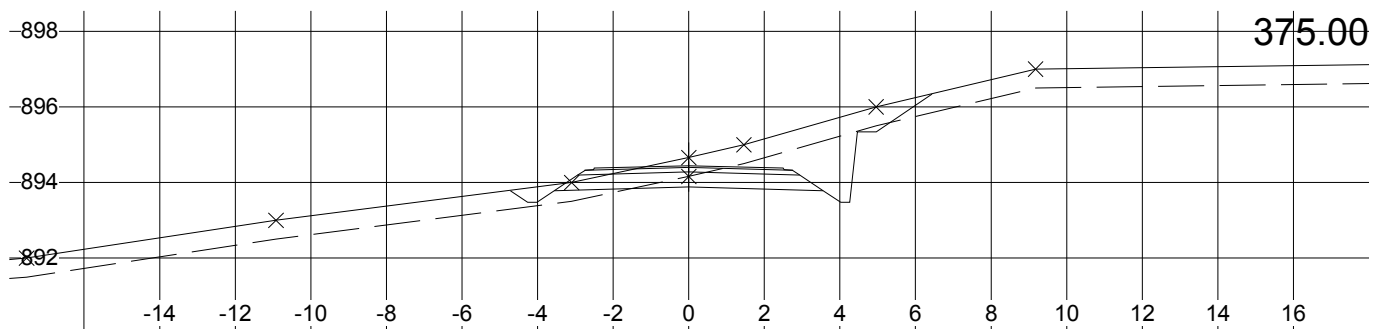
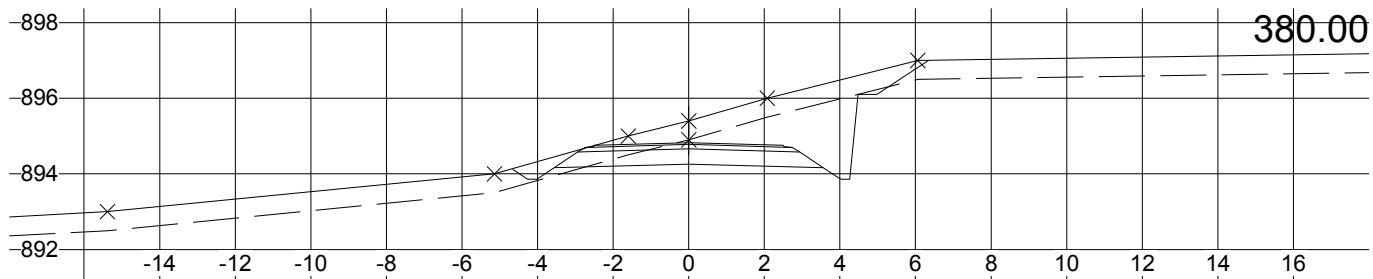

L:\IMA 4.7, Lisens: Plankontoret Hallvard Homme AS, Parsell: Parsell1.ps1

Rauland Invest AS Holtarvegen Tverrprofil	Tegnet av AST	Saksbehandler
	Sidemannskontr.	Prosjektansvarlig AST
Plankontoret H. Homme AS 4747 Valle Tlf: 37 93 70 00, Fax: 37 93 74 74, E-Post: post@plankontoret.no	Dato 03.12.2009	Målestokk 1: 200
	Prosj.nr. 2219-v1	1: 200
	Tegn.nr. -Tp-13	Rev.

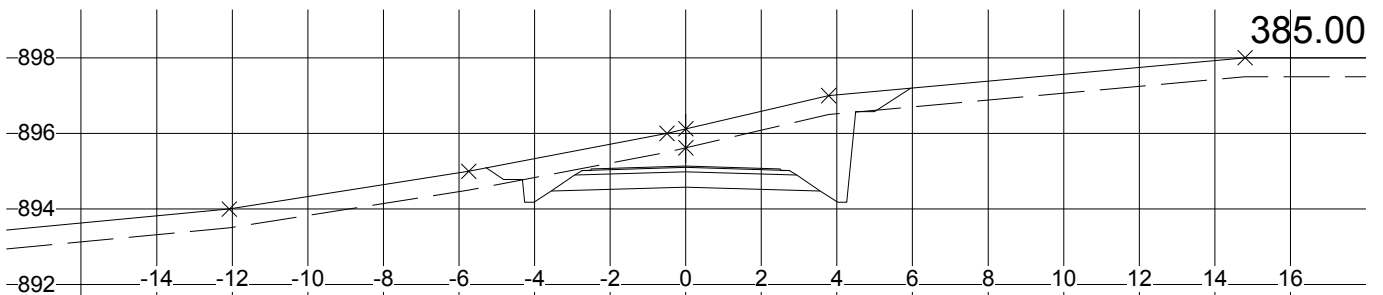
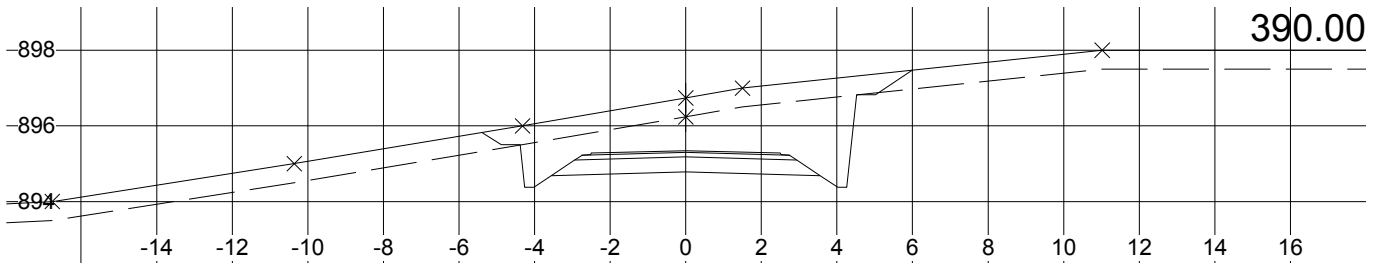
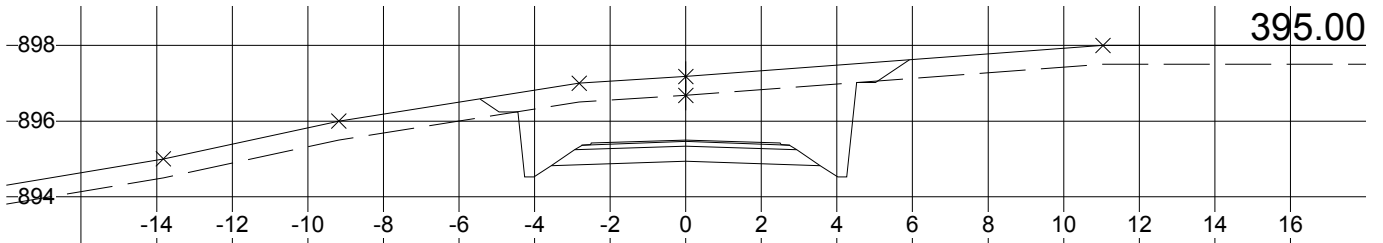
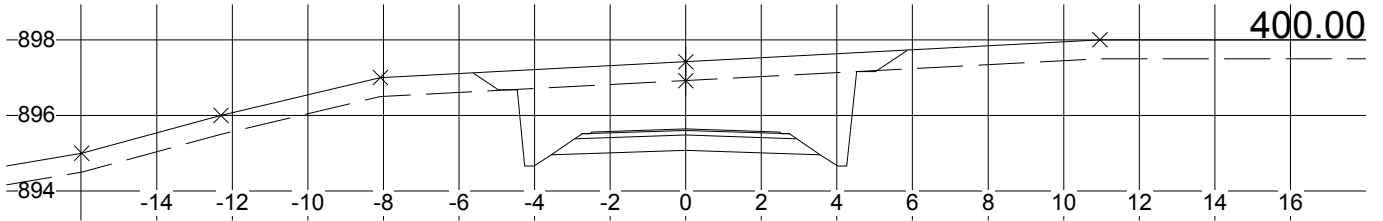
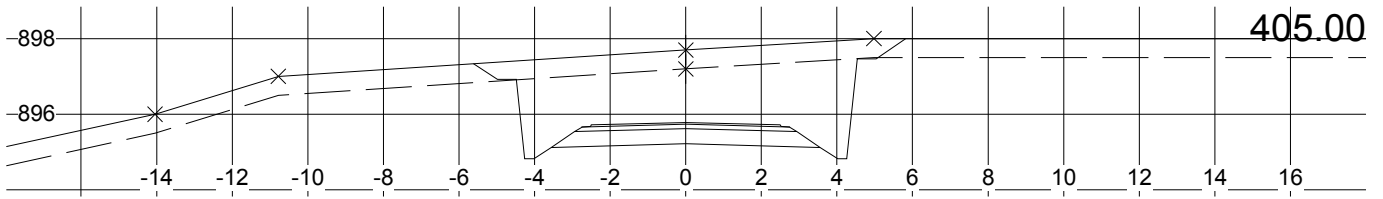

LIMA 4.7, Lisens: Plankontoret Hallvard Homme AS, Parsell, Parsell1.ps1

Rauland Invest AS Holtarvegen Tverrprofil	Tegnet av AST	Saksbehandler
	Sidemannskontroll.	Prosjektansvarlig AST
	Dato 03.12.2009	Målestokk 1: 200
	Prosj.nr. 2219-v1	1: 200
	Tegn.nr. -Tp-14	Rev.
Plankontoret H. Homme AS 4747 Valle Tlf: 37 93 70 00, Fax: 37 93 74 74, E-Post: post@plankontoret.no		

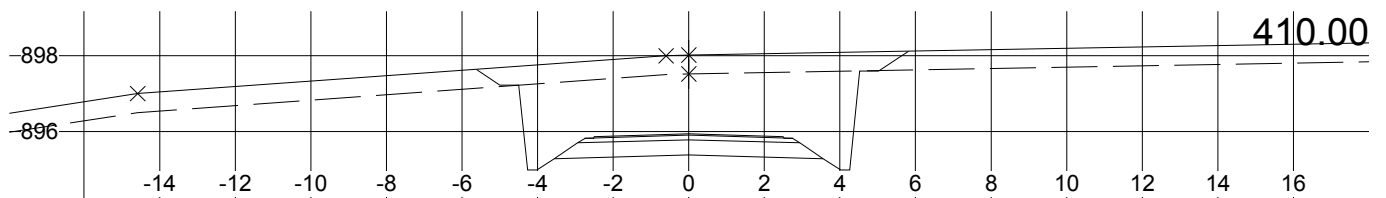
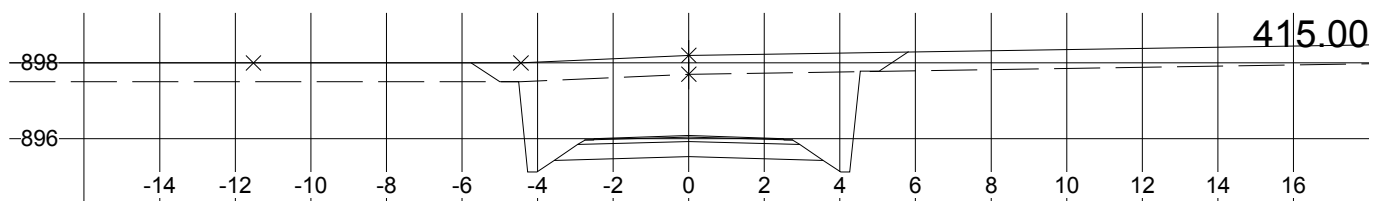
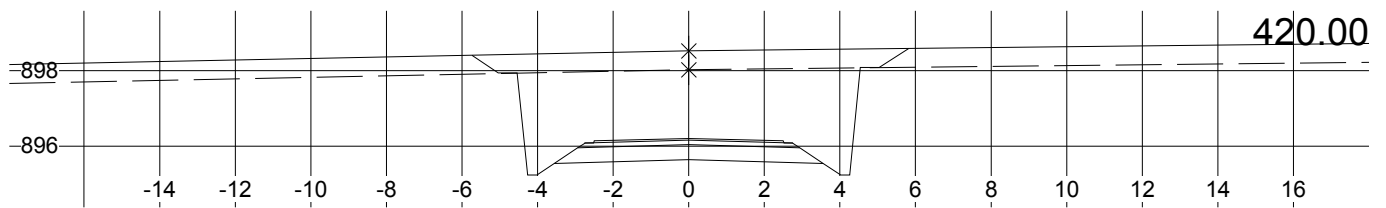
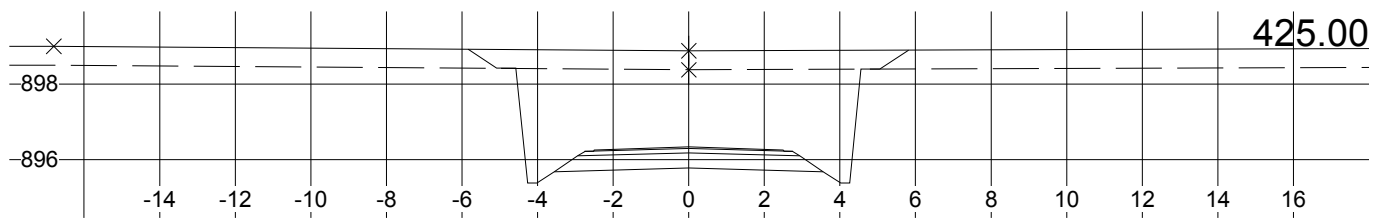
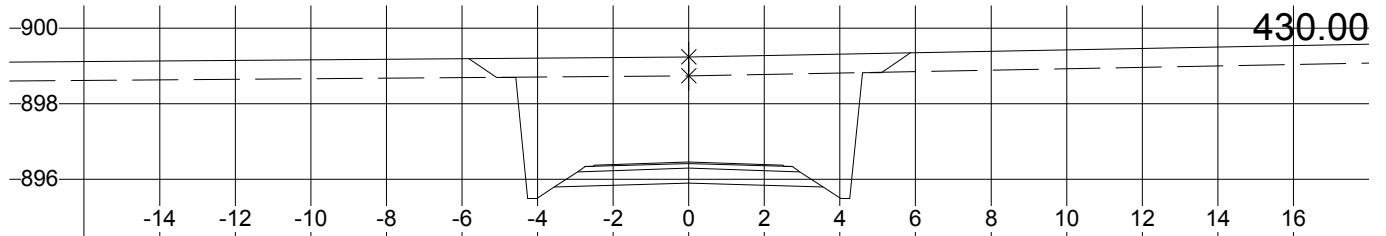
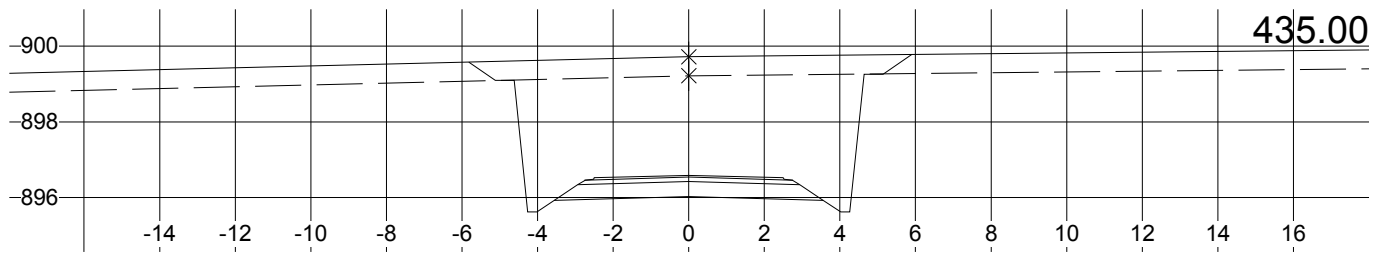

L:\IMA 4.7, Lisens: Plankontoret Hallvard Homme AS, Parsell: Parsell1.ps1

Rauland Invest AS Holtarvegen Tverrprofil	Tegnet av AST	Saksbehandler
	Sidemannskonstr.	Prosjektansvarlig AST
Plankontoret H. Homme AS 4747 Valle Tlf: 37 93 70 00, Fax: 37 93 74 74, E-Post: post@plankontoret.no	Dato 03.12.2009	Målestokk 1: 200
	Prosj.nr. 2219-v1	1: 200
	Tegn.nr. -Tp-15	Rev.

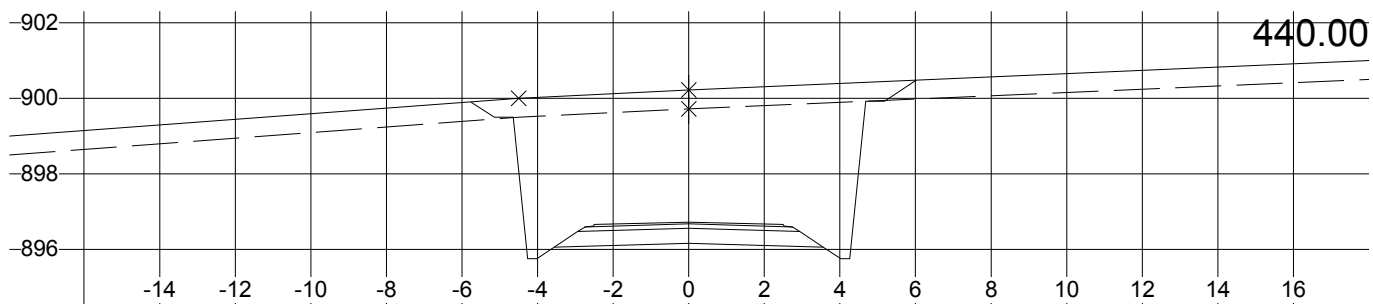
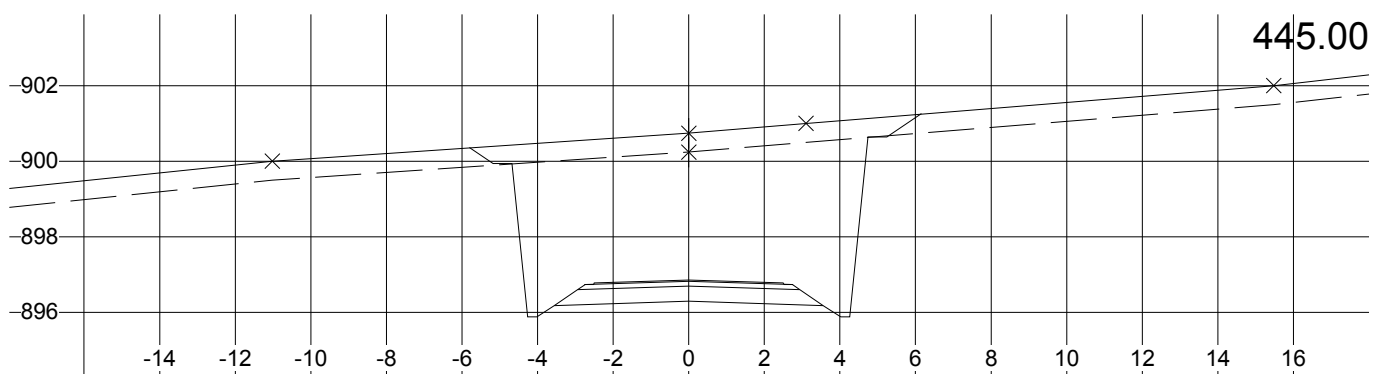
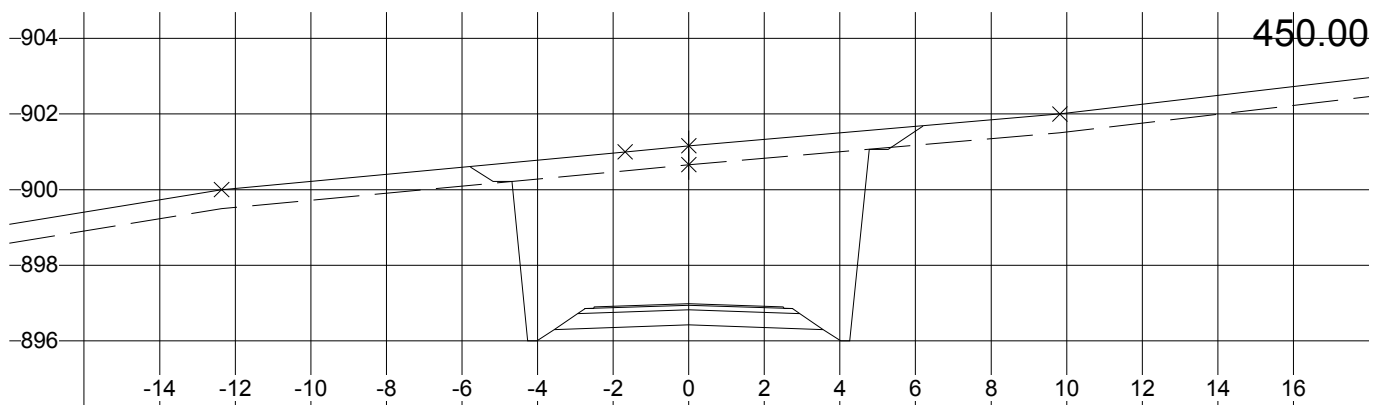

L:\IMA 4.7, Lisens: Plankontoret Hallvard Homme AS, Parsell: Parsell1.psl

Rauland Invest AS Holtarvegen Tverrprofil	Tegnet av AST	Saksbehandler
	Sidemannskontr.	Prosjektansvarlig AST
Plankontoret H. Homme AS 4747 Valle Tlf: 37 93 70 00, Fax: 37 93 74 74, E-Post: post@plankontoret.no	Dato 03.12.2009	Målestokk 1: 200
	Prosj.nr. 2219-v1	1: 200
	Tegn.nr. -Tp-16	Rev.

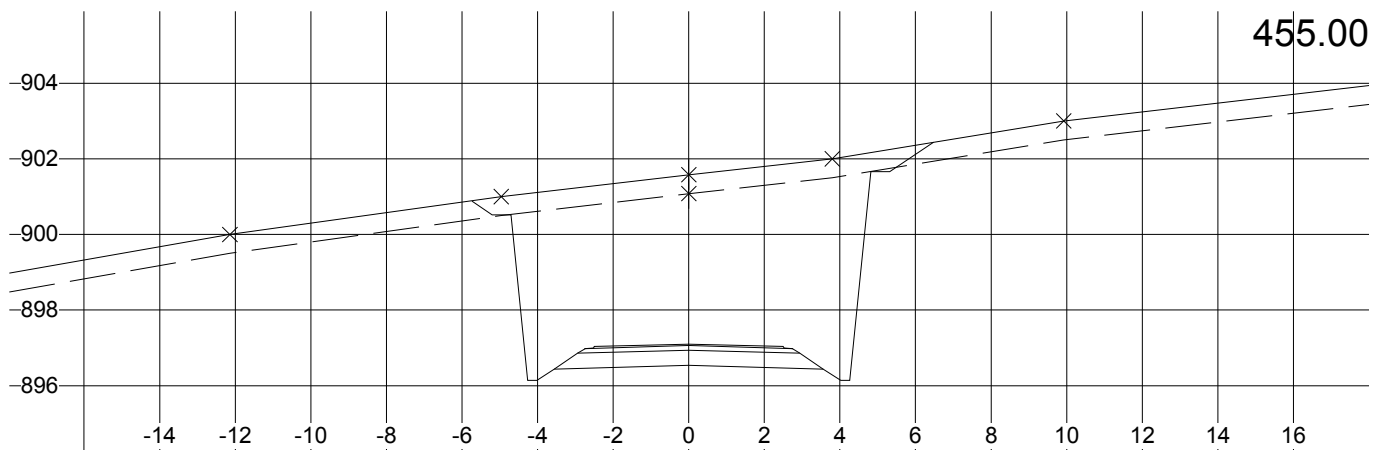
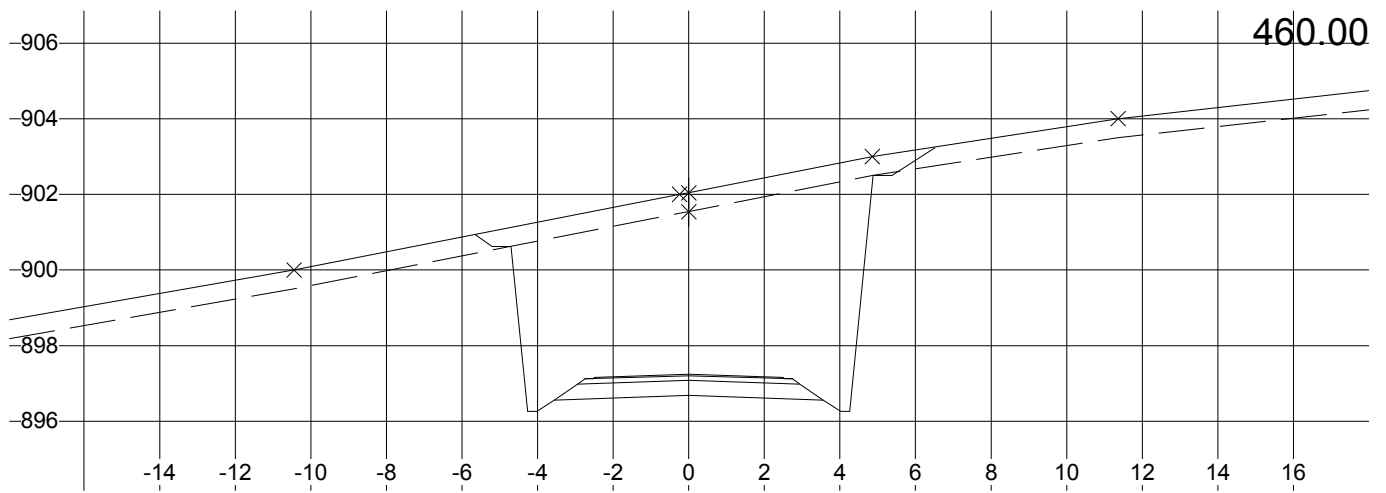
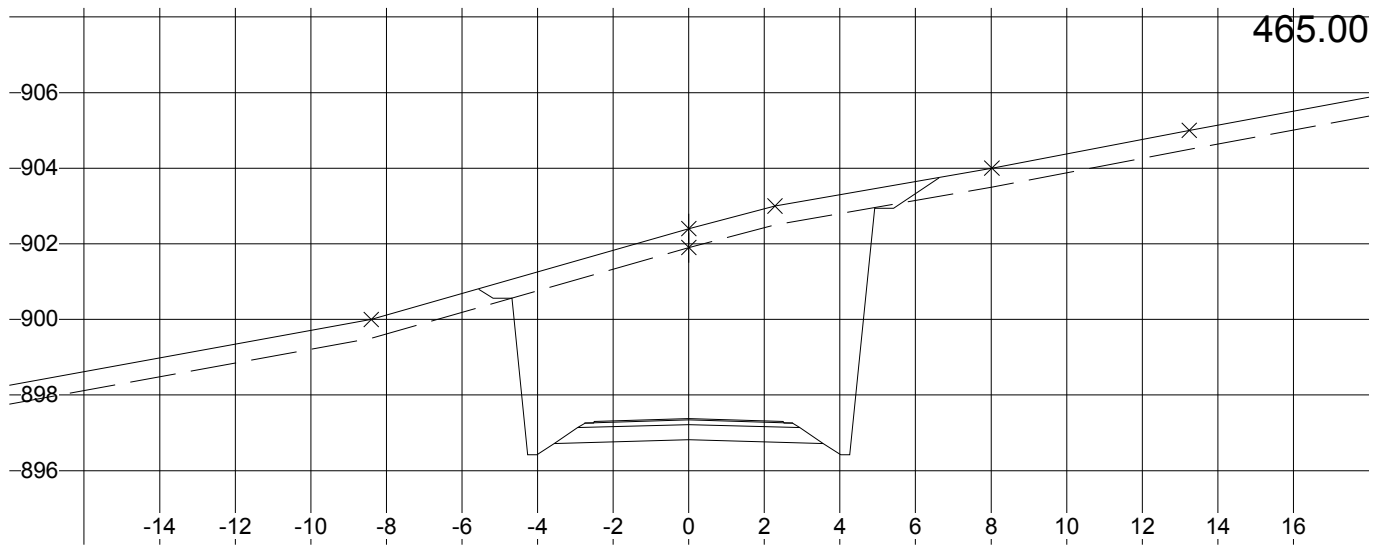

L:\IMA 4.7, Lisens: Plankontoret Hallvard Homme AS, Parsell: Parsell1.psl

Rauland Invest AS Holtarvegen Tverrprofil	Tegnet av AST	Saksbehandler
	Sidemannskontr.	Prosjektansvarlig AST
Plankontoret H. Homme AS 4747 Valle Tlf: 37 93 70 00, Fax: 37 93 74 74, E-Post: post@plankontoret.no	Dato 03.12.2009	Målestokk 1: 200
	Prosj.nr. 2219-v1	1: 200
	Tegn.nr. -Tp-17	Rev.

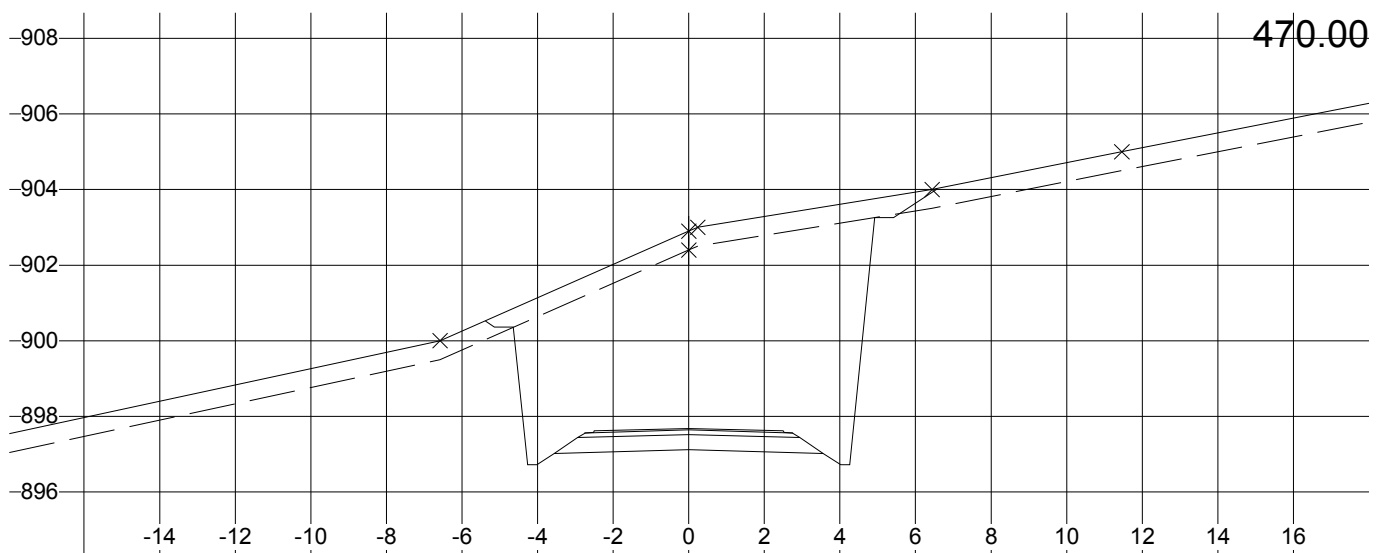
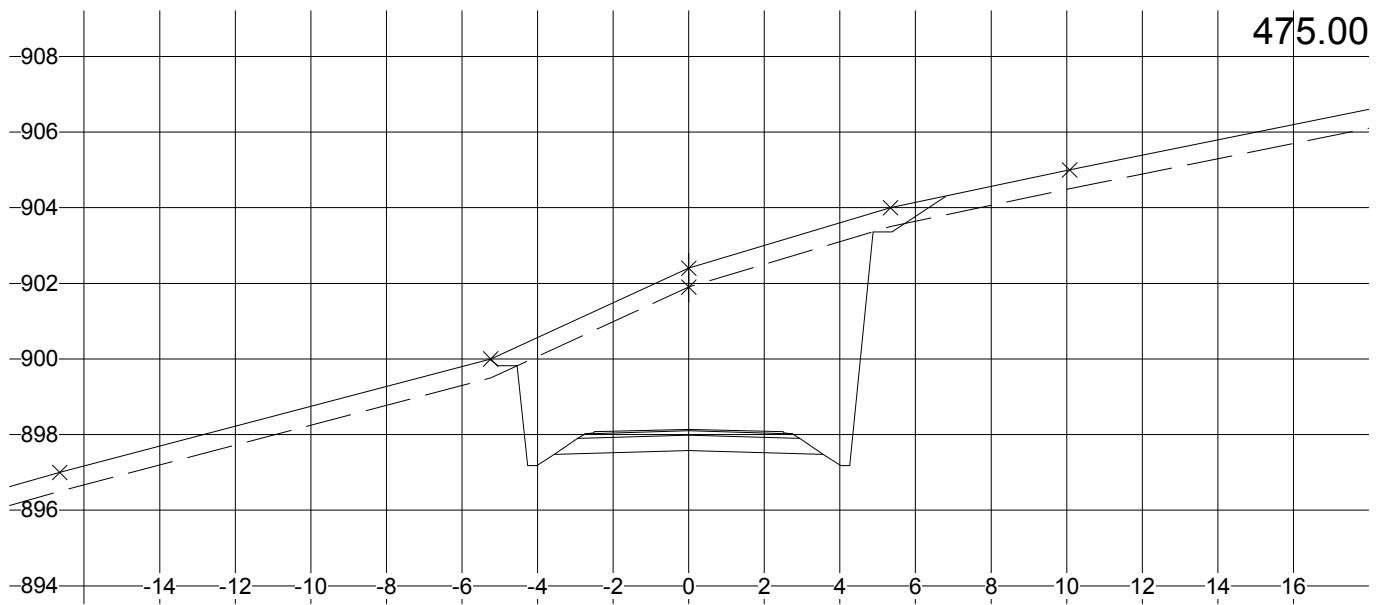

L:\IMA 4.7, Lisens: Plankontoret Hallvard Homme AS, Parsell: Parsell1.psl

Rauland Invest AS Holtarvegen Tverrprofil	Tegnet av AST	Saksbehandler
	Sidemannskontr.	Prosjektansvarlig AST
Plankontoret H. Homme AS 4747 Valle Tlf: 37 93 70 00, Fax: 37 93 74 74, E-Post: post@plankontoret.no	Dato 03.12.2009	Målestokk 1: 200
	Prosj.nr. 2219-v1	1: 200
	Tegn.nr. -Tp-18	Rev.

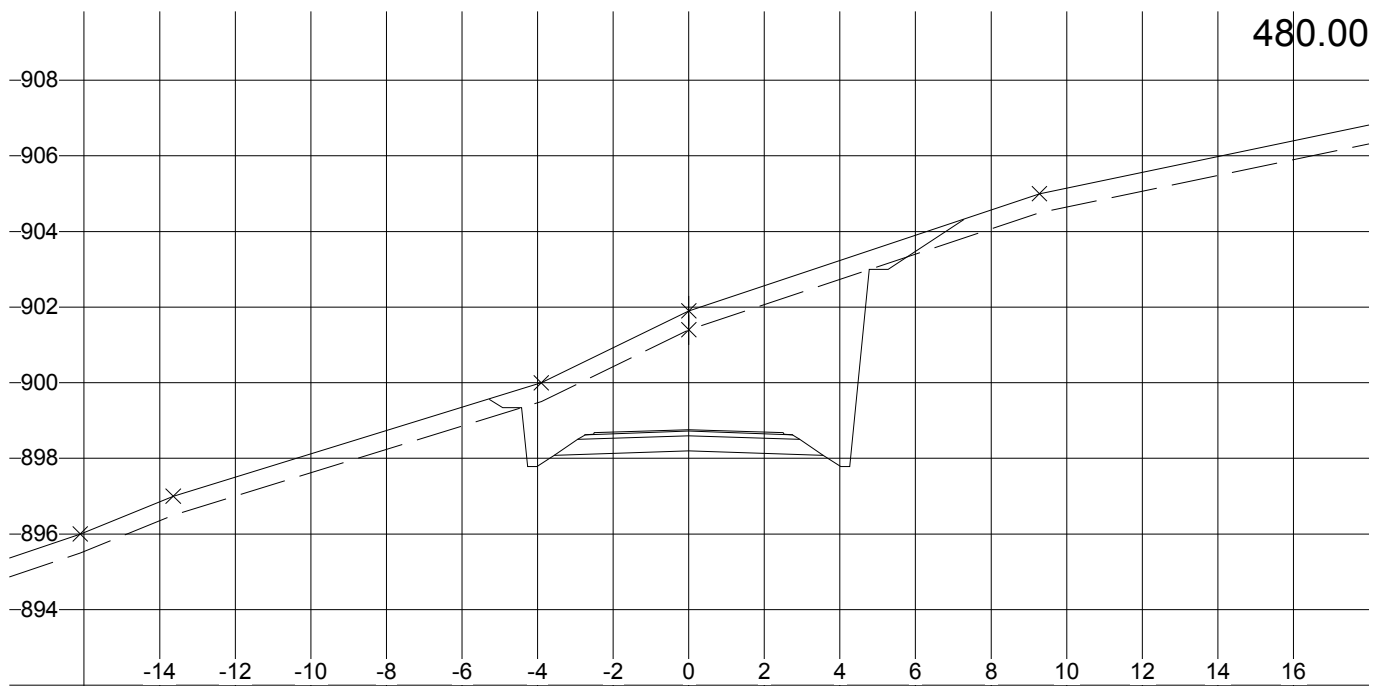
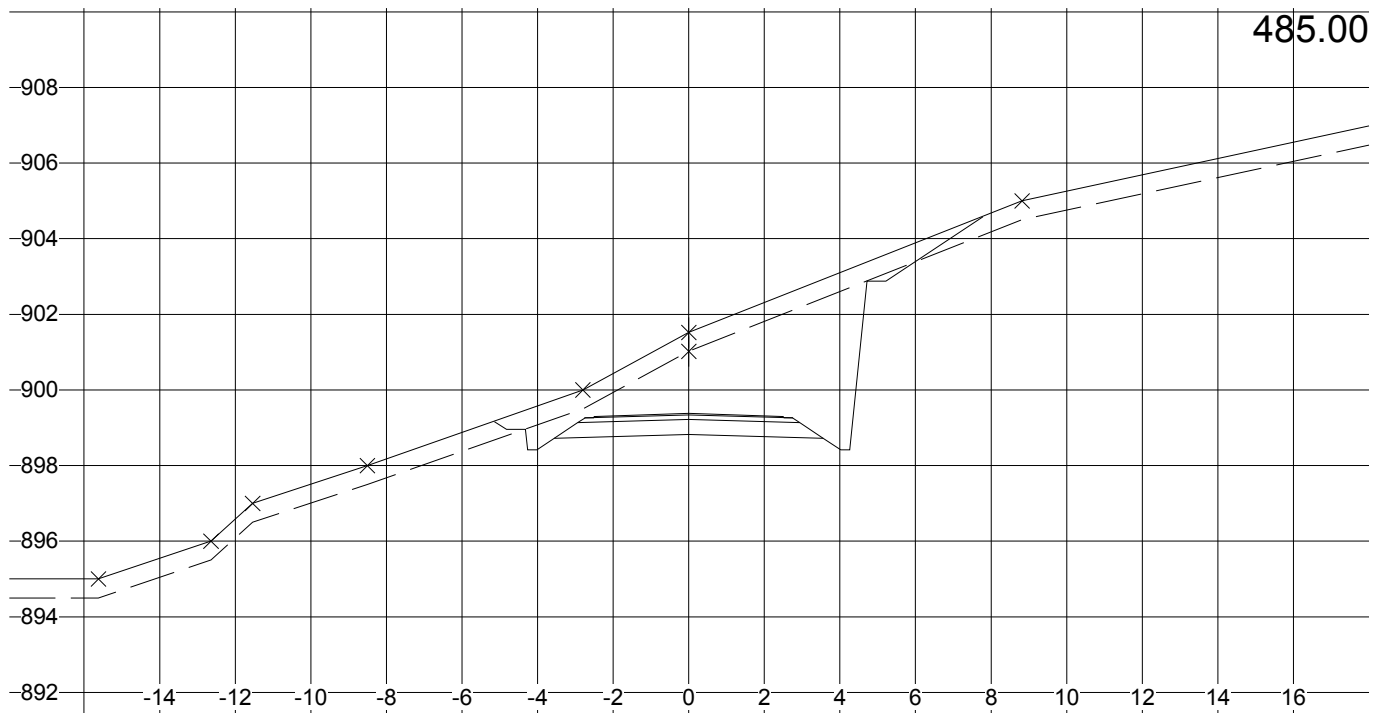

L:\IMA 4.7, Lisens: Plankontoret Hallvard Homme AS, Parsell: Parsell1,psl

Rauland Invest AS Holtarvegen Tverrprofil	Tegnet av AST	Saksbehandler
	Sidemannskontr.	Prosjektansvarlig AST
Plankontoret H. Homme AS 4747 Valle Tlf: 37 93 70 00, Fax: 37 93 74 74, E-Post: post@plankontoret.no	Dato 03.12.2009	Målestokk 1: 200
	Prosj.nr. 2219-v1	1: 200
	Tegn.nr. -Tp-19	Rev.

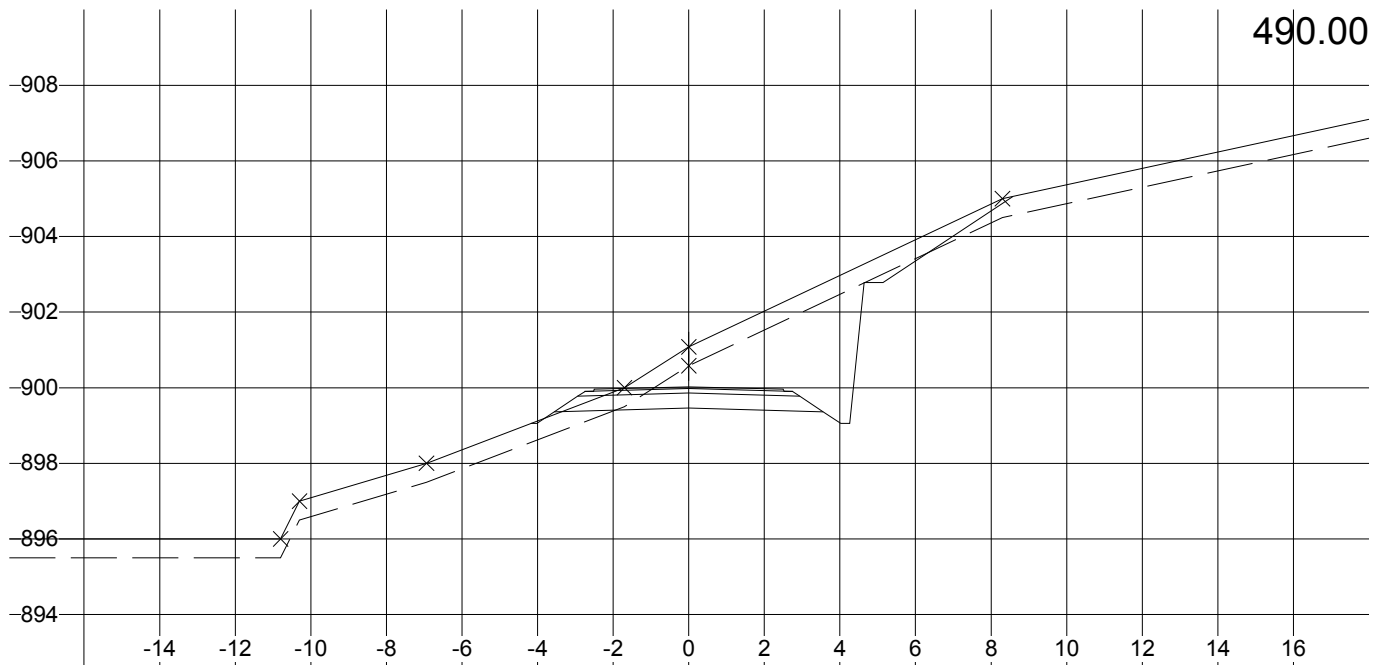
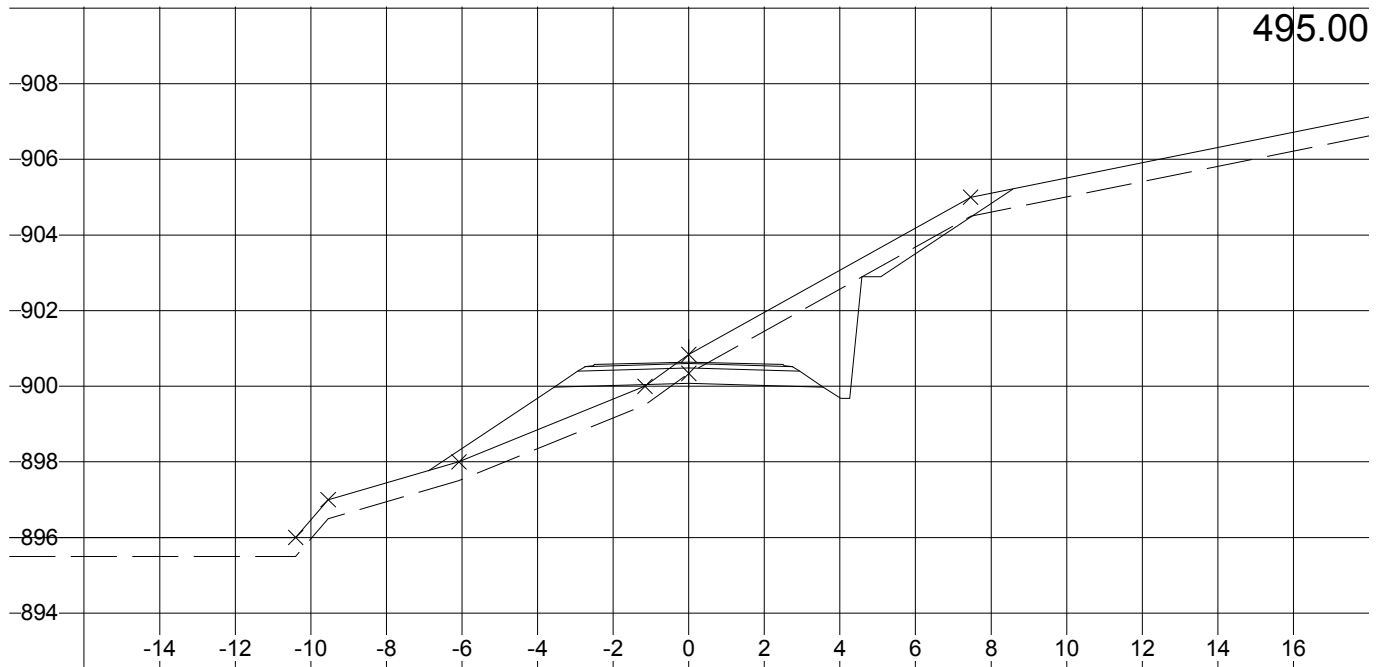

L:\IMA 4.7, Lisens: Plankontoret Hallvard Homme AS, Parsell: Parsell1.psl

Rauland Invest AS Holtarvegen Tverrprofil	Tegnet av AST	Saksbehandler
	Sidemannskontr.	Prosjektansvarlig AST
Plankontoret H. Homme AS 4747 Valle Tlf: 37 93 70 00, Fax: 37 93 74 74, E-Post: post@plankontoret.no	Dato 03.12.2009	Målestokk 1: 200
	Prosj.nr. 2219-v1	1: 200
	Tegn.nr. -Tp-20	Rev.

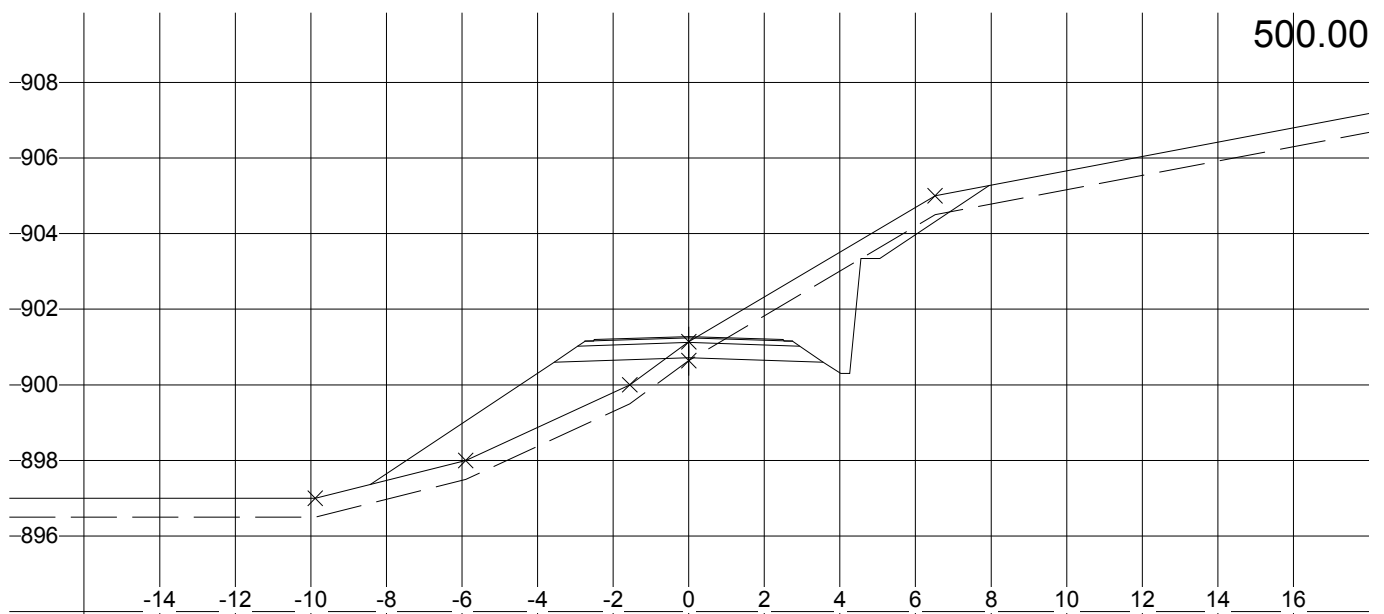
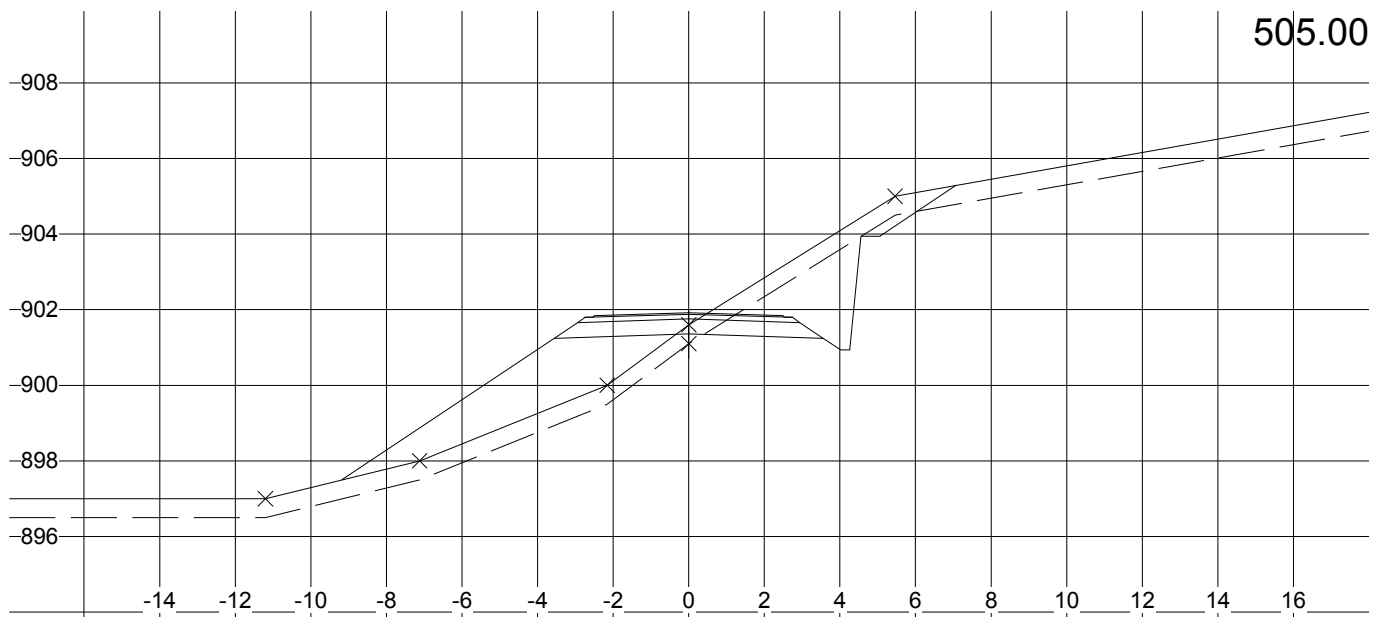

L:\IMA 4.7, Lisens: Plankontoret Hallvard Homme AS, Parsell: Parsell1,psl

Rauland Invest AS Holtarvegen Tverrprofil	Tegnet av AST	Saksbehandler
	Sidemannskontr.	Prosjektansvarlig AST
Plankontoret H. Homme AS 4747 Valle Tlf: 37 93 70 00, Fax: 37 93 74 74, E-Post: post@plankontoret.no	Dato 03.12.2009	Målestokk 1: 200
	Prosj.nr. 2219-v1	1: 200
	Tegn.nr. -Tp-21	Rev.

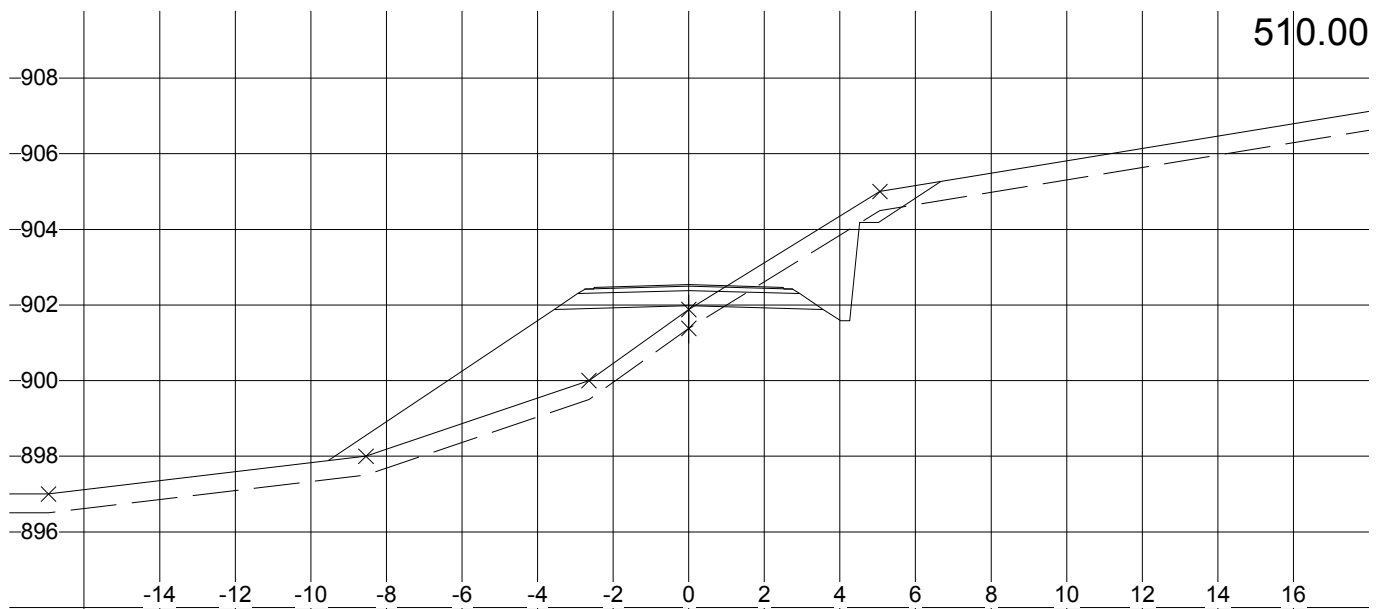
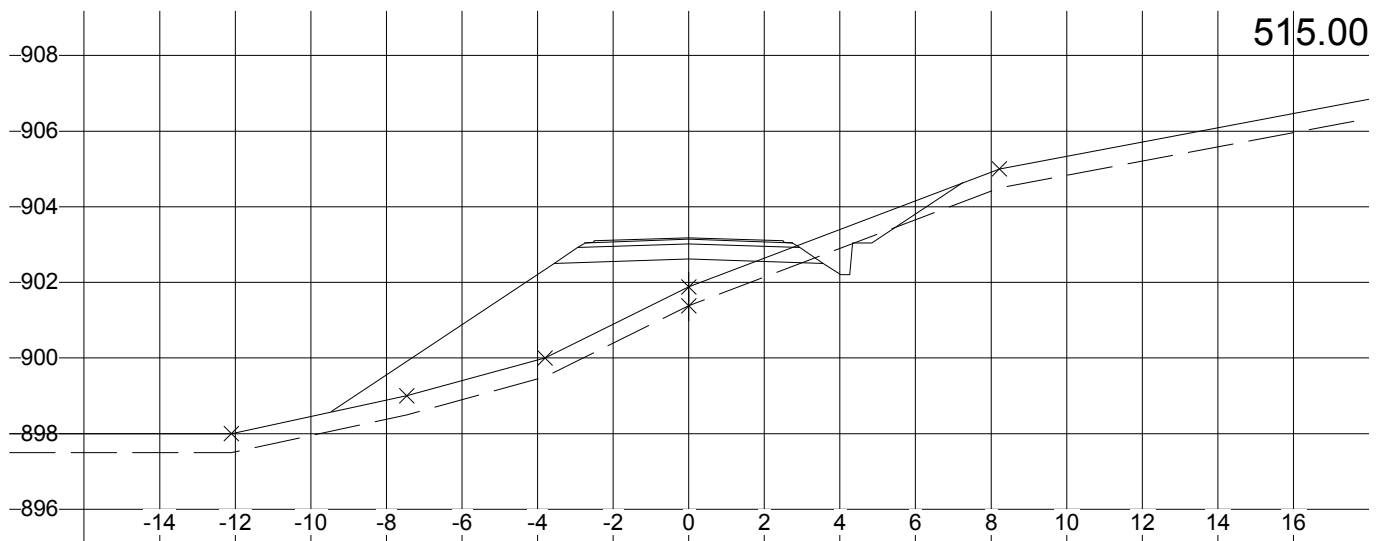

L:\IMA 4.7, Lisens: Plankontoret Hallvard Homme AS, Parsell: Parsell1,psl

Rauland Invest AS Holtarvegen Tverrprofil	Tegnet av AST	Saksbehandler
	Sidemannskontr.	Prosjektansvarlig AST
Plankontoret H. Homme AS 4747 Valle Tlf: 37 93 70 00, Fax: 37 93 74 74, E-Post: post@plankontoret.no	Dato 03.12.2009	Målestokk 1: 200
	Prosj.nr. 2219-v1	1: 200
	Tegn.nr. -Tp-22	Rev.

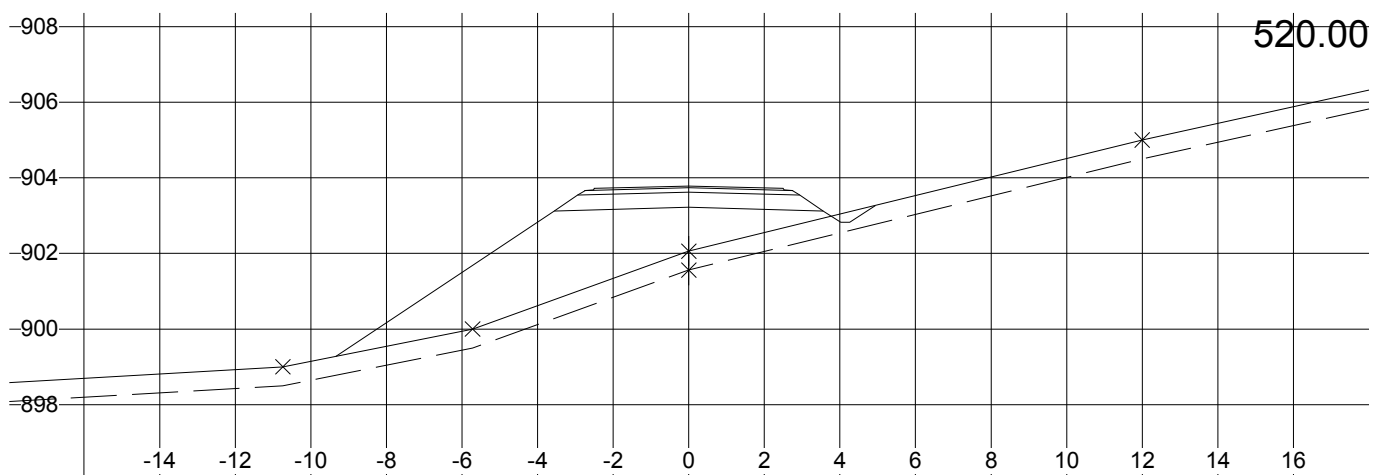
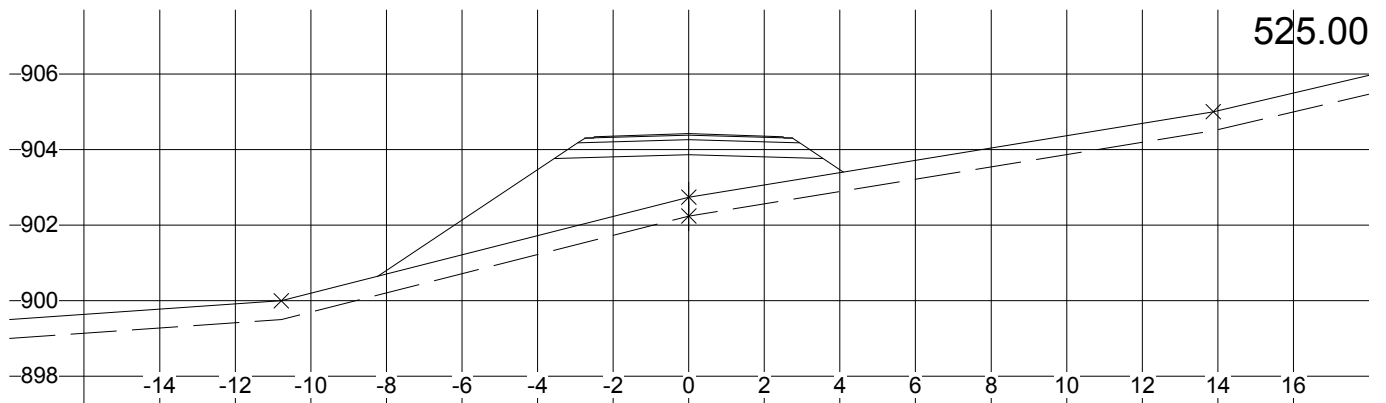
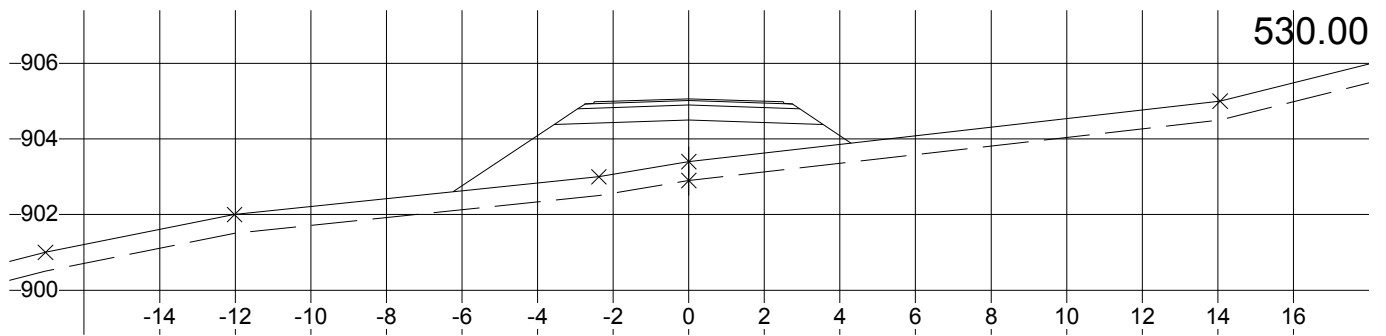

L:\IMA 4.7, Lisens: Plankontoret Hallvard Homme AS, Parsell: Parsell1.ps1

Rauland Invest AS Holtarvegen Tverrprofil	Tegnet av AST	Saksbehandler
	Sidemannskontr.	Prosjektansvarlig AST
	Dato 03.12.2009	Målestokk 1: 200
	Prosj.nr. 2219-v1	1: 200
Plankontoret H. Homme AS 4747 Valle Tlf: 37 93 70 00, Fax: 37 93 74 74, E-Post: post@plankontoret.no	Tegn.nr. -Tp-23	Rev.

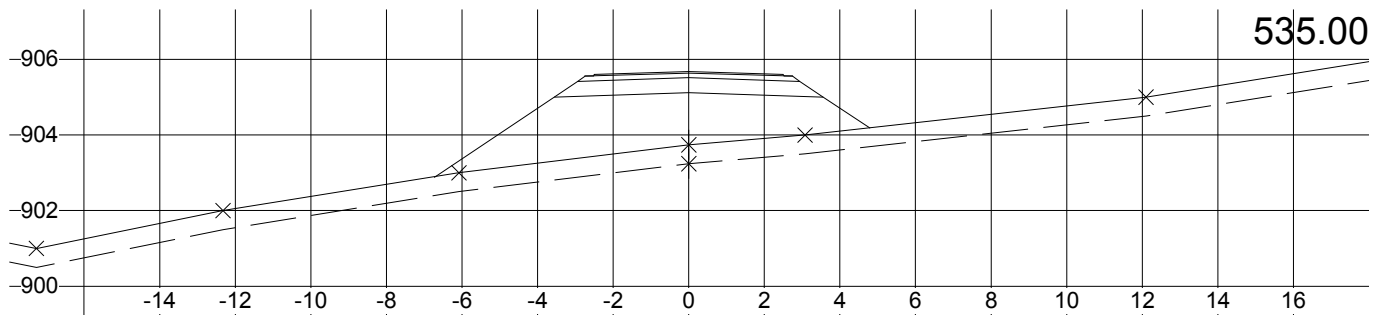
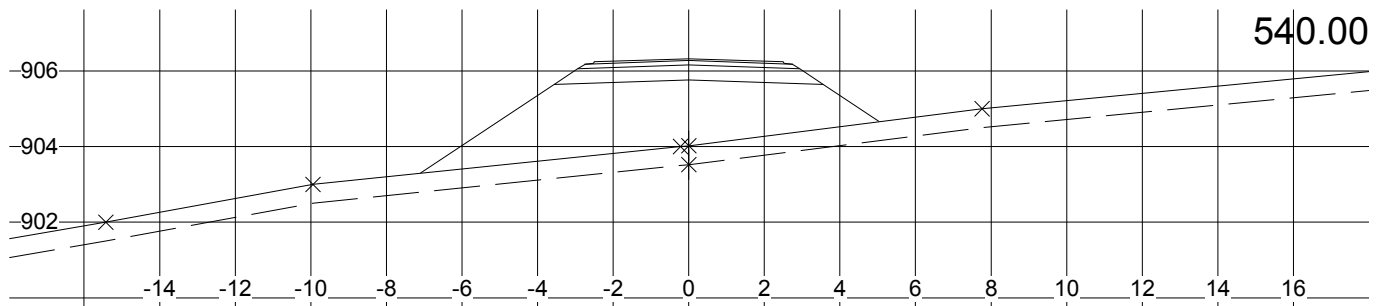
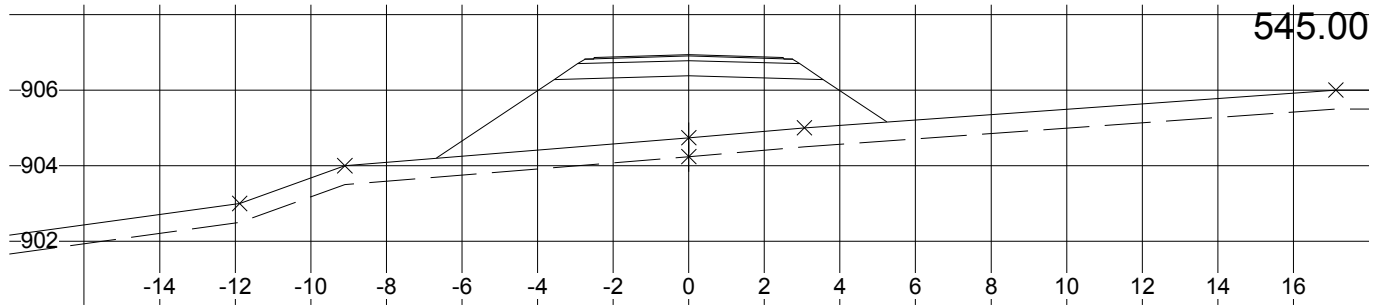
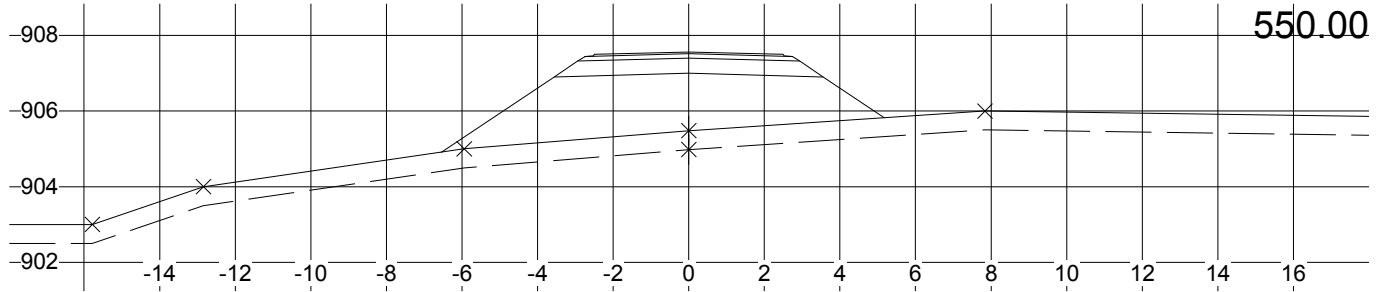

LIMA 4.7, Lisens: Plankontoret Hallvard Homme AS, Parsell: Parsell1.psl

Rauland Invest AS Holtarvegen Tverrprofil	Tegnet av AST	Saksbehandler
	Sidemannskonstr.	Prosjektansvarlig AST
Plankontoret H. Homme AS 4747 Valle Tlf: 37 93 70 00, Fax: 37 93 74 74, E-Post: post@plankontoret.no	Dato 03.12.2009	Målestokk 1: 200 1: 200
	Prosj.nr. 2219-v1	
	Tegn.nr. -Tp-24	Rev.

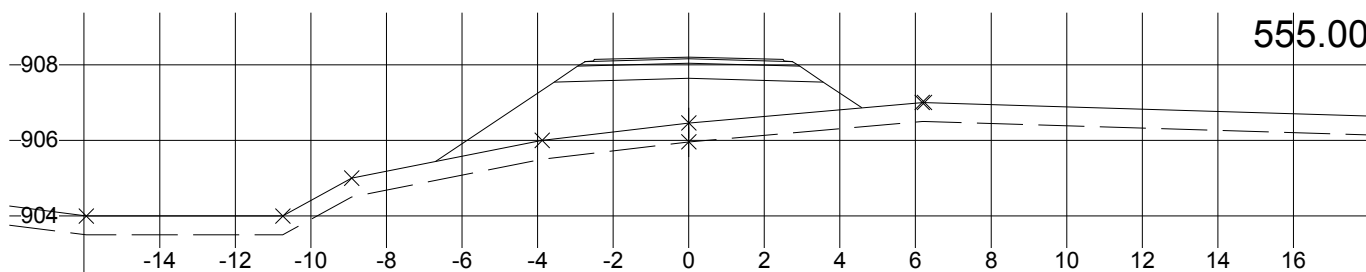
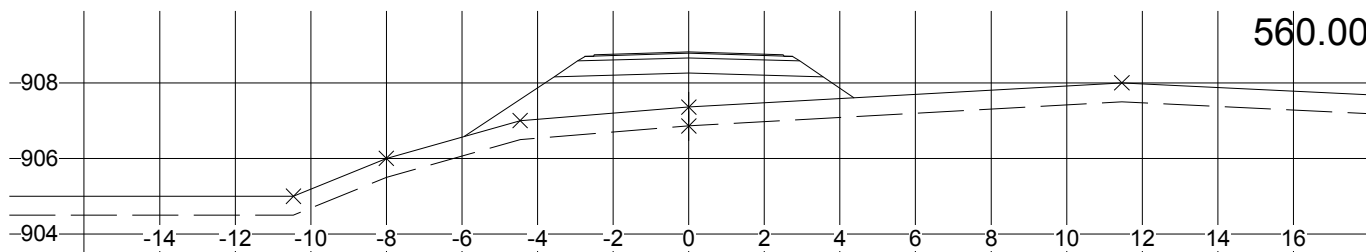
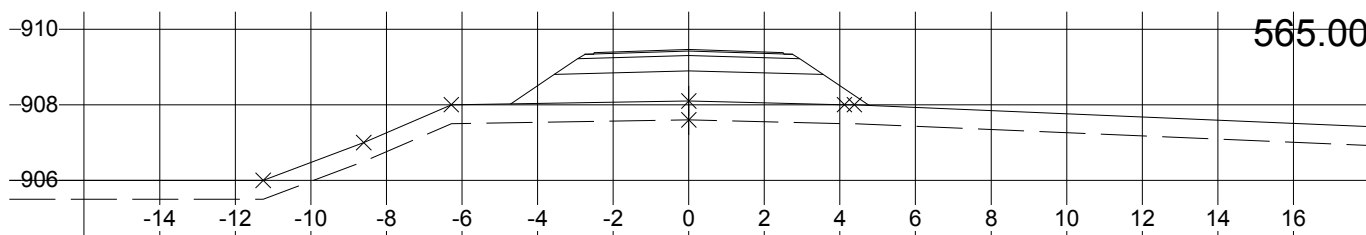
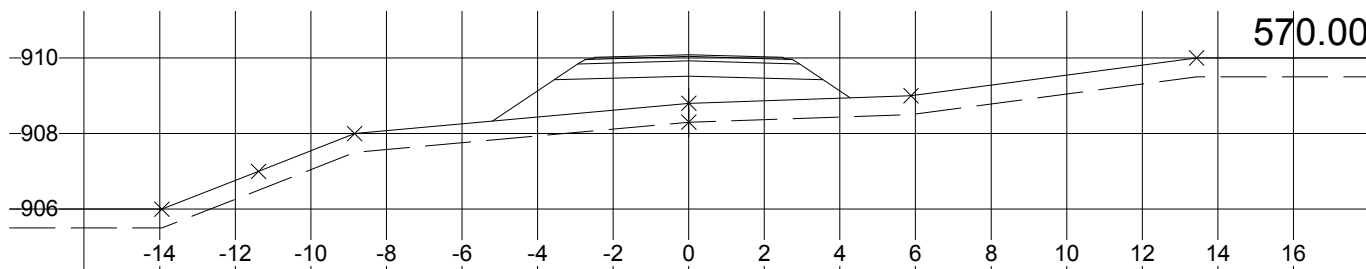
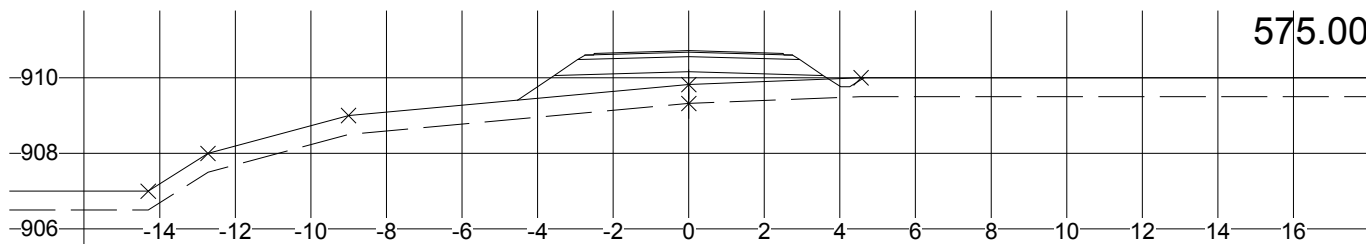

L:\IMA 4.7, Lisens: Plankontoret Hallvard Homme AS, Parsell: Parsell1.psl

Rauland Invest AS Holtarvegen Tverrprofil	Tegnet av AST	Saksbehandler
	Sidemannskontr.	Prosjektansvarlig AST
Plankontoret H. Homme AS 4747 Valle Tlf: 37 93 70 00, Fax: 37 93 74 74, E-Post: post@plankontoret.no	Dato 03.12.2009	Målestokk 1: 200
	Prosj.nr. 2219-v1	1: 200
	Tegn.nr. -Tp-25	Rev.

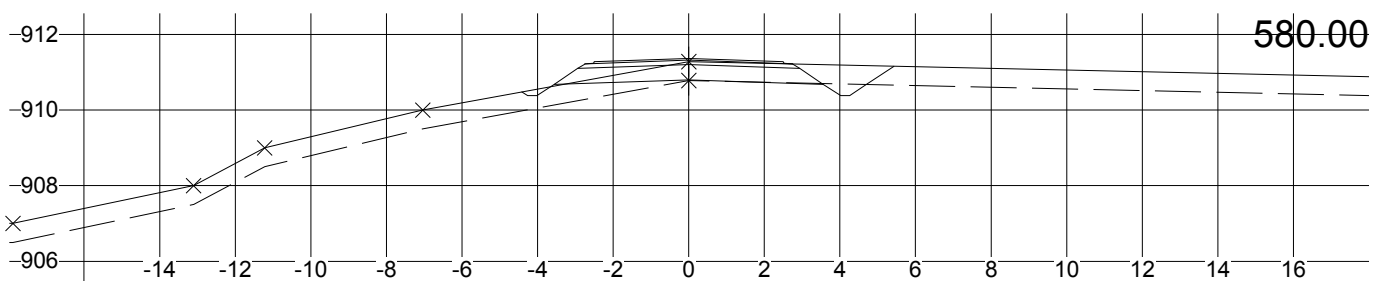
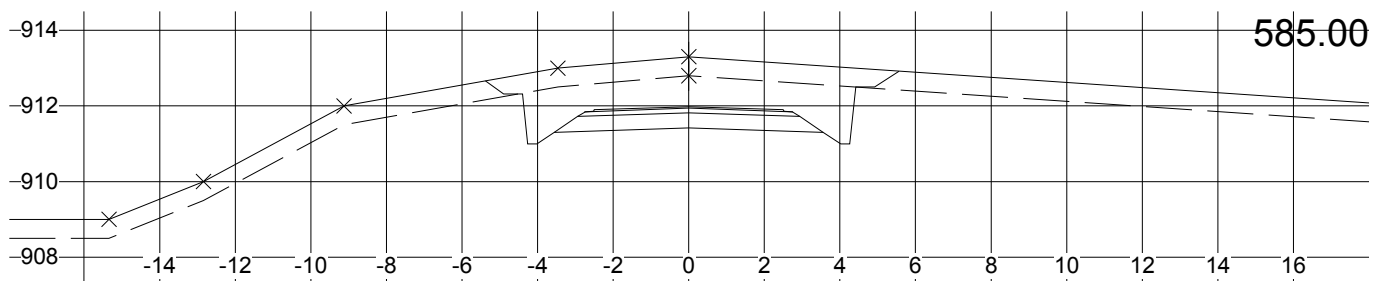
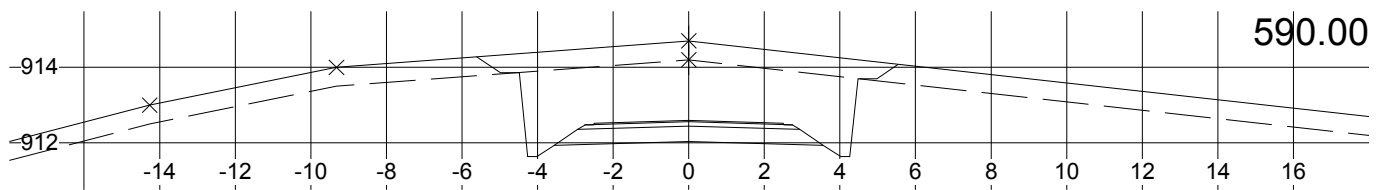
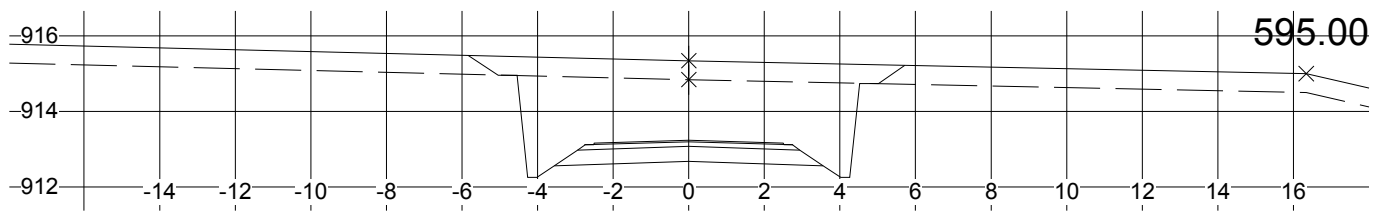
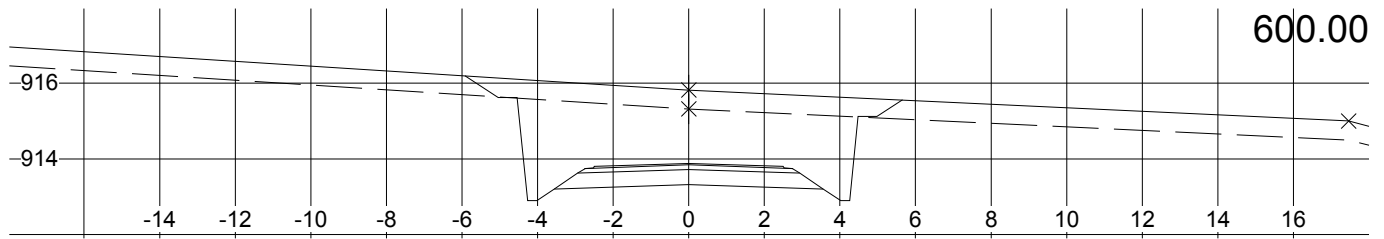

L:\IMA 4.7, Lisens: Plankontoret Hallvard Homme AS, Parsell: Parsell1.psl

Rauland Invest AS Holtarvegen Tverrprofil	Tegnet av AST	Saksbehandler
	Sidemannskontr.	Prosjektansvarlig AST
Plankontoret H. Homme AS 4747 Valle Tlf: 37 93 70 00, Fax: 37 93 74 74, E-Post: post@plankontoret.no	Dato 03.12.2009	Målestokk 1: 200
	Prosj.nr. 2219-v1	1: 200
	Tegn.nr. -Tp-26	Rev.

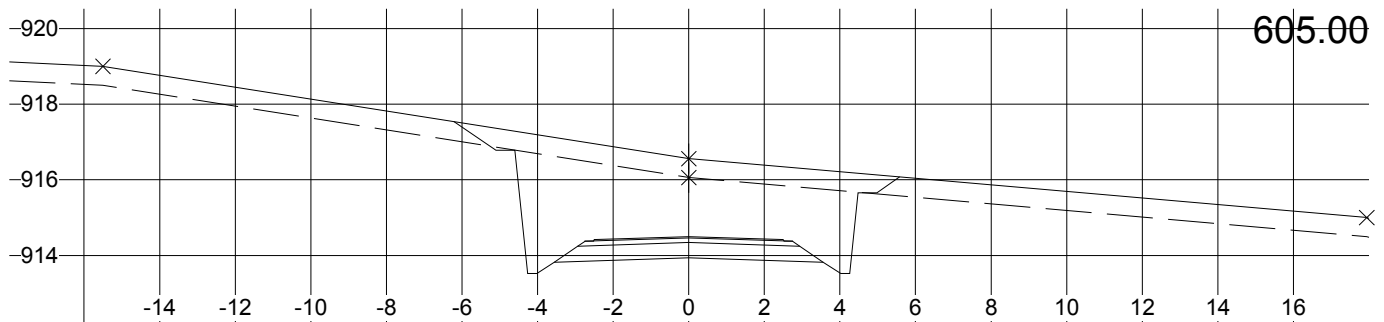
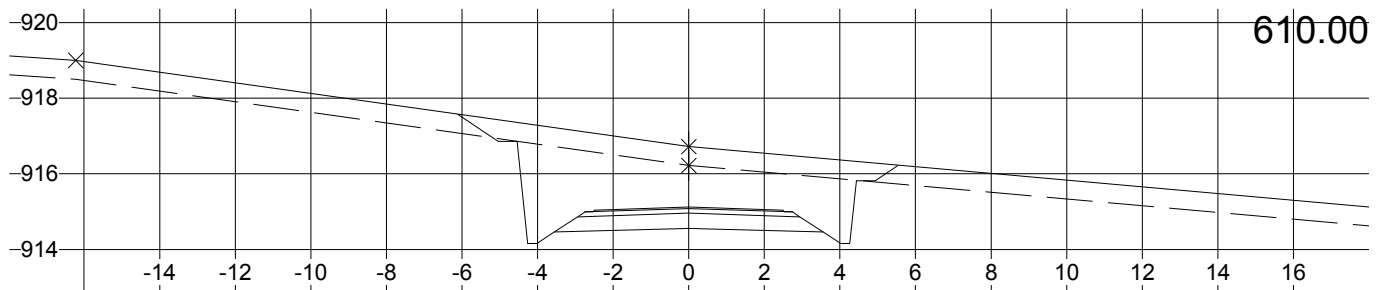
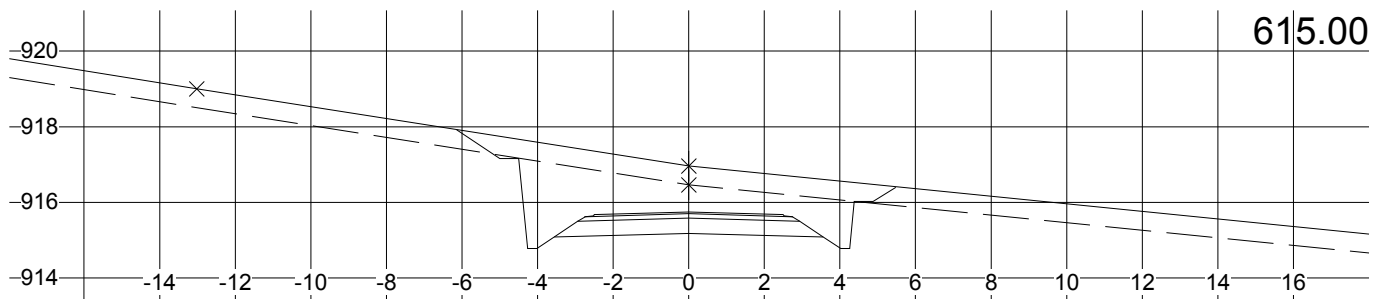
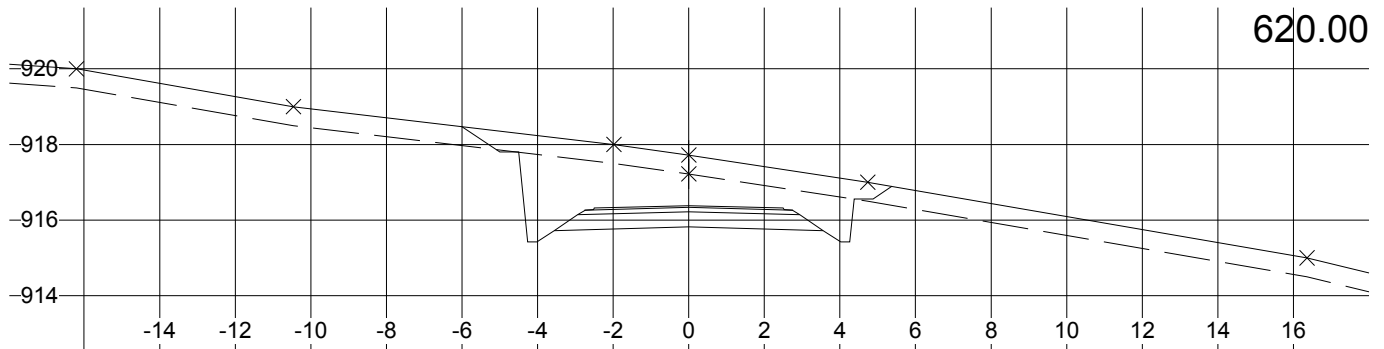

LIMA 4.7, Lisens: Plankontoret Hallvard Homme AS, Parsell: Parsell1.ps1

Rauland Invest AS Holtarvegen Tverrprofil	Tegnet av AST	Saksbehandler
	Sidemannskontr.	Prosjektansvarlig AST
Plankontoret H. Homme AS 4747 Valle Tlf: 37 93 70 00, Fax: 37 93 74 74, E-Post: post@plankontoret.no	Dato 03.12.2009	Målestokk 1: 200
	Prosj.nr. 2219-v1	1: 200
	Tegn.nr. -Tp-27	Rev.

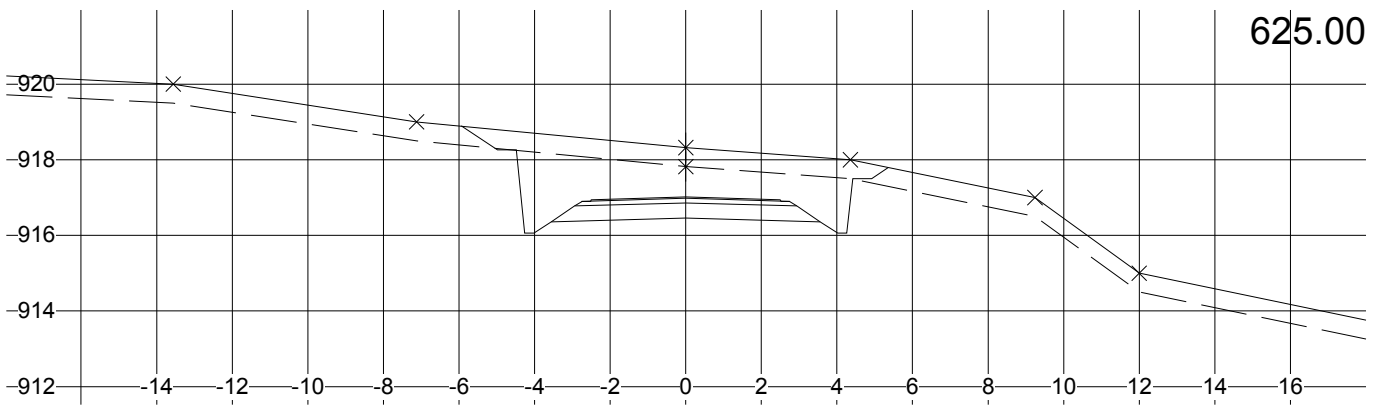
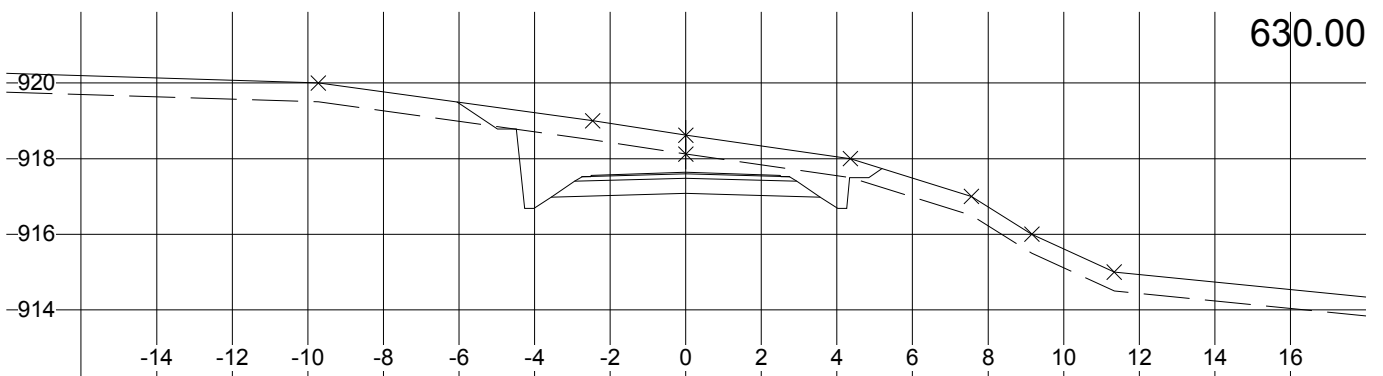
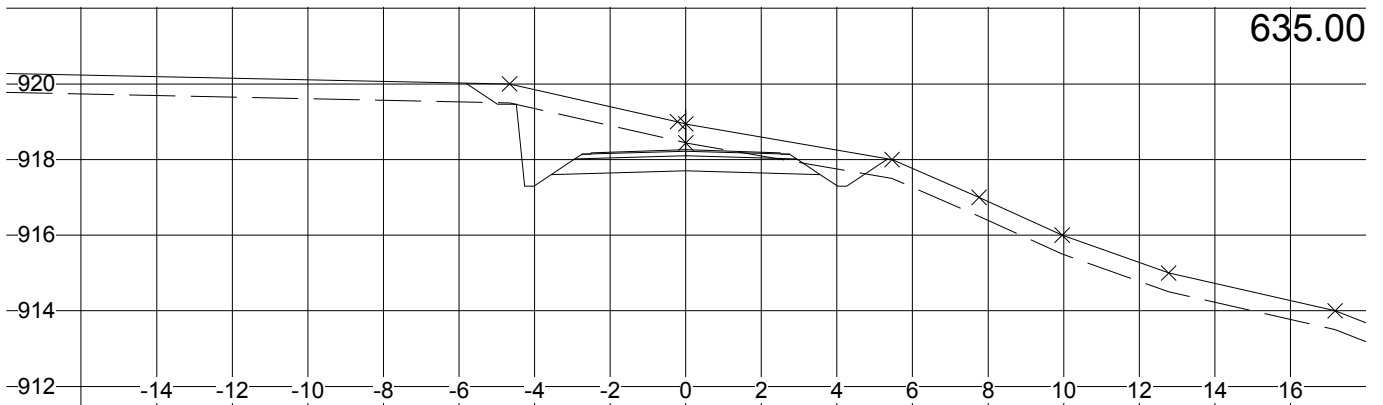

Rauland Invest AS Holtarvegen Tverrprofil	Tegnet av AST	Saksbehandler
	Sidemannskontr.	Prosjektansvarlig AST
	Dato 03.12.2009	Målestokk 1: 200
	Prosj.nr. 2219-v1	1: 200
Plankontoret H. Homme AS 4747 Valle Tlf: 37 93 70 00, Fax: 37 93 74 74, E-Post: post@plankontoret.no	Tegn.nr. -Tp-28	Rev.

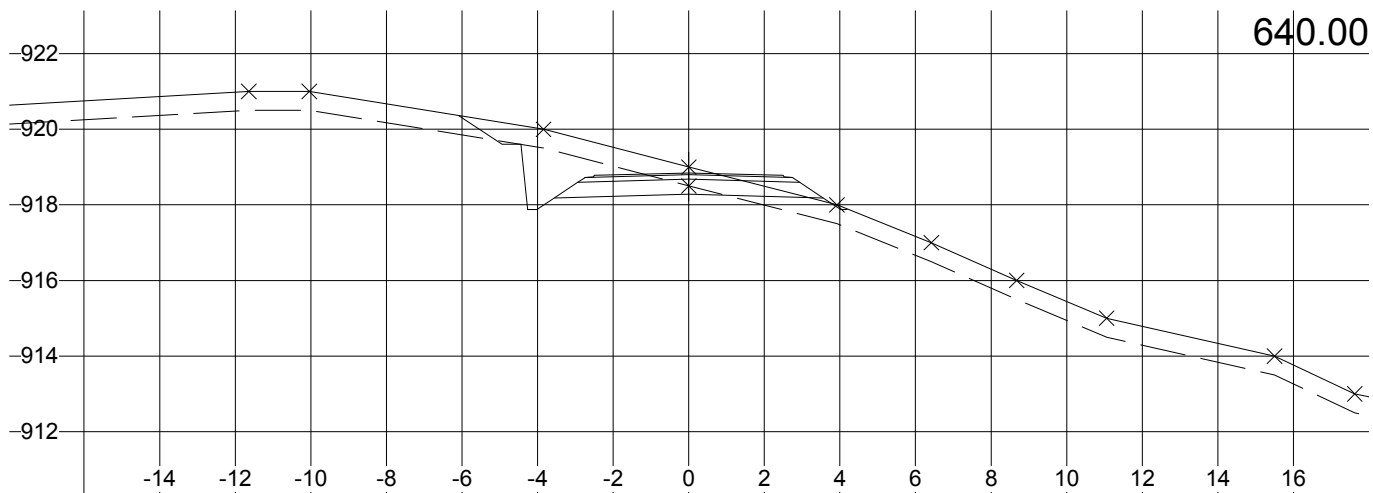
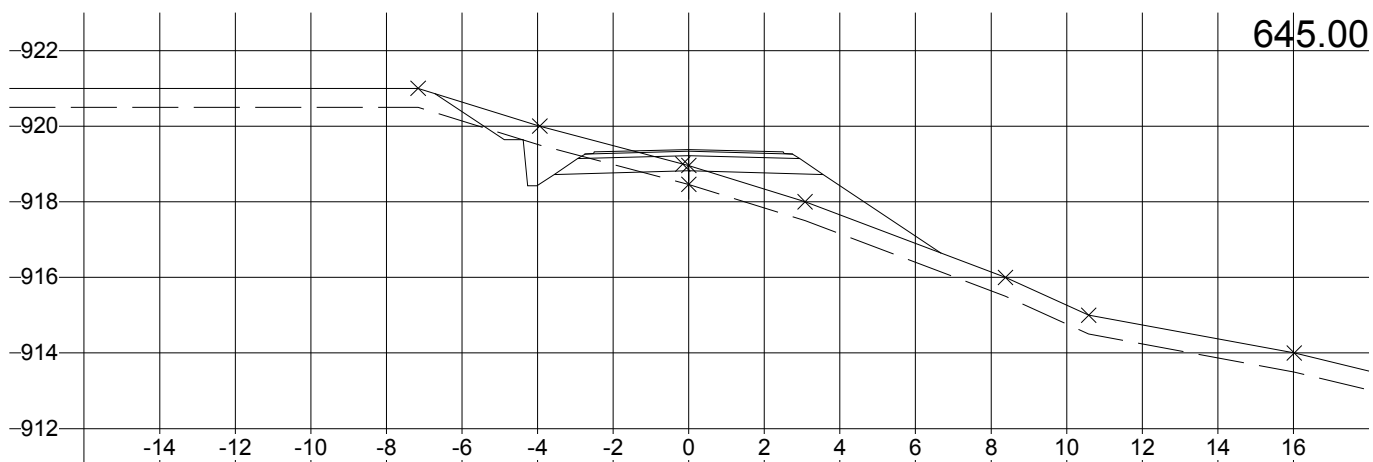
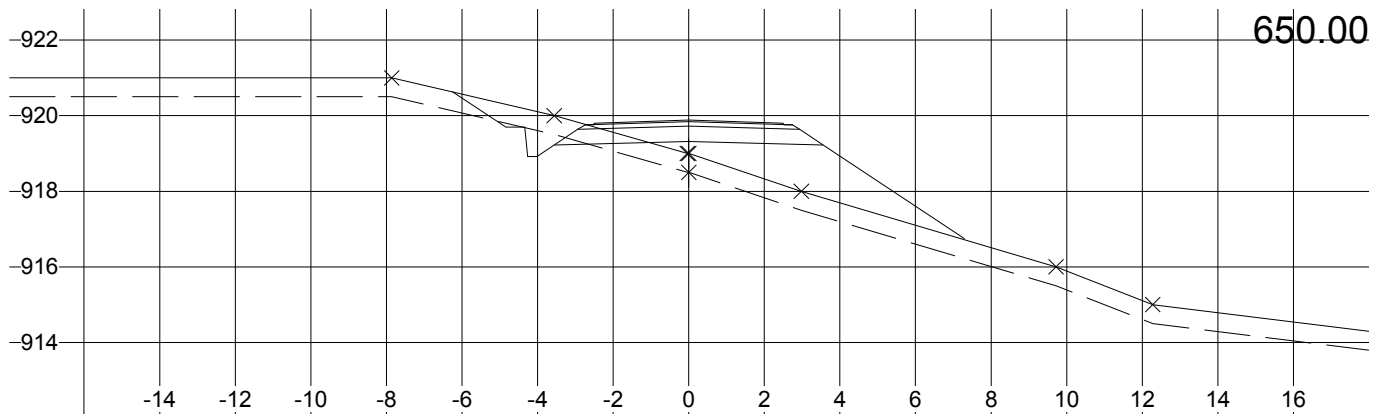

L:\IMA 4.7, Lisens: Plankontoret Hallvard Homme AS, Parsell: Parsell1.ps1

Rauland Invest AS Holtarvegen Tverrprofil	Tegnet av AST	Saksbehandler
	Sidemannskontr.	Prosjektansvarlig AST
Plankontoret H. Homme AS 4747 Valle Tlf: 37 93 70 00, Fax: 37 93 74 74, E-Post: post@plankontoret.no	Dato 03.12.2009	Målestokk 1: 200
	Prosj.nr. 2219-v1	1: 200
	Tegn.nr. -Tp-29	Rev.

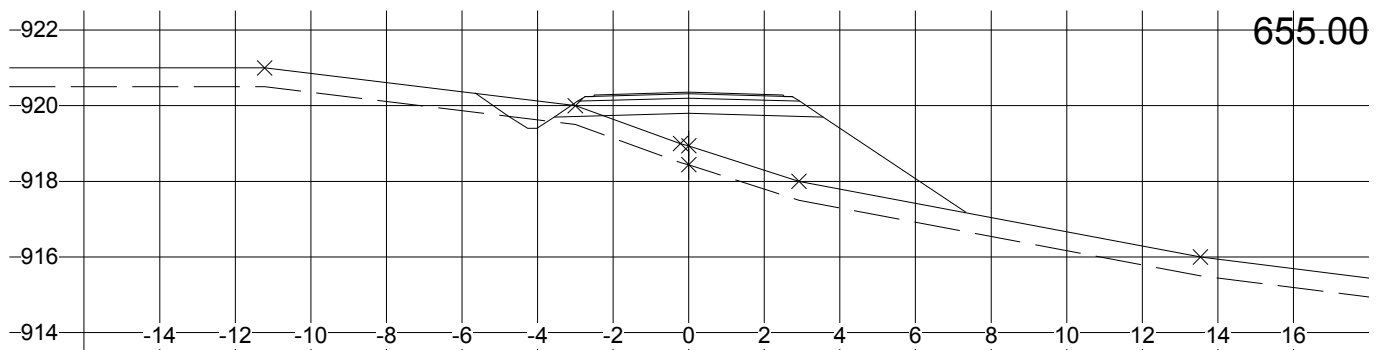
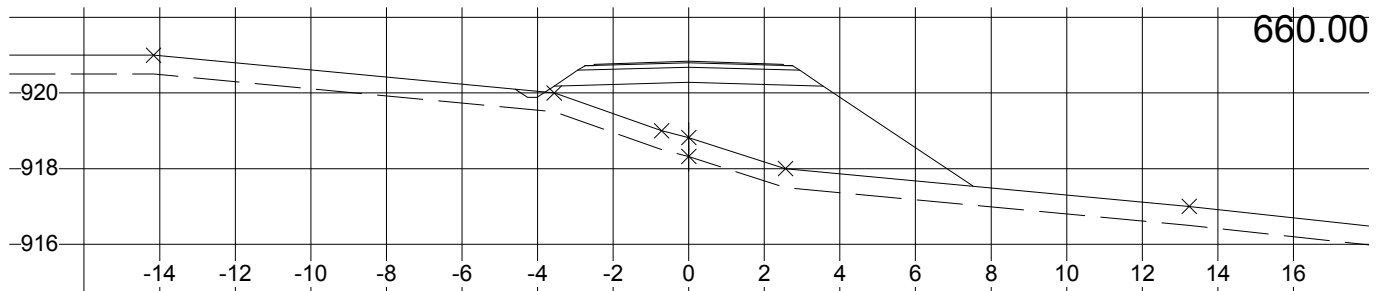
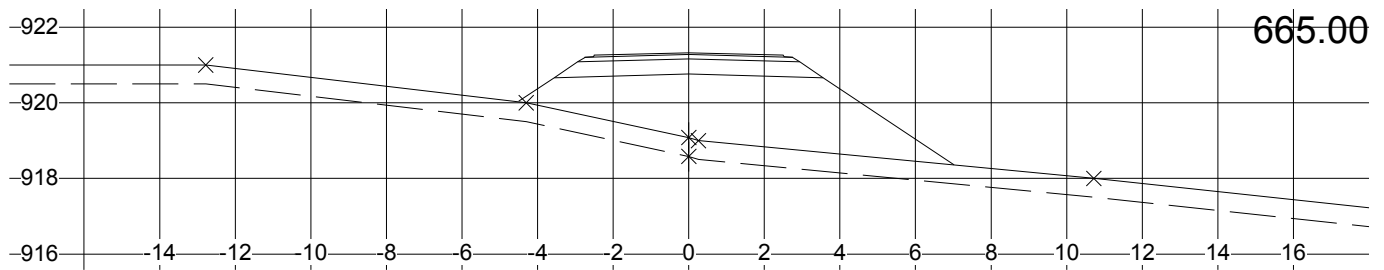
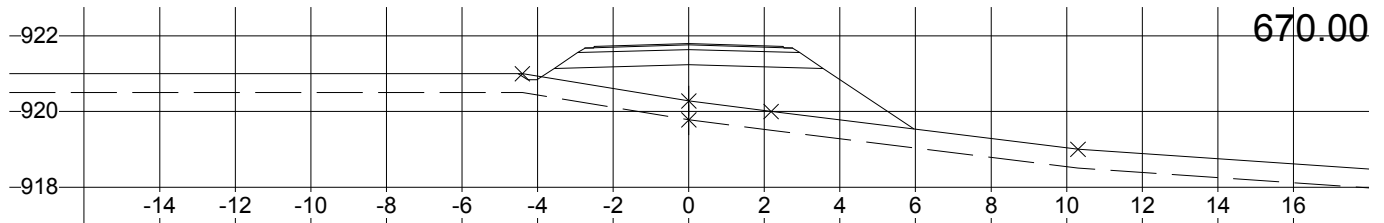
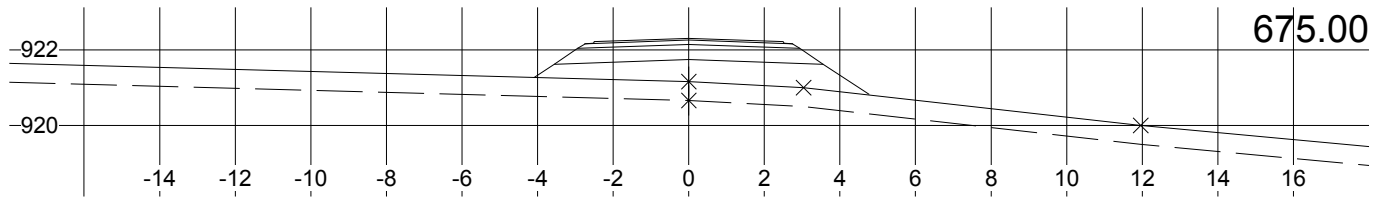

L:\IMA 4.7, Lisens: Plankontoret Hallvard Homme AS, Parsell: Parsell1,psl

Rauland Invest AS Holtarvegen Tverrprofil	Tegnet av AST	Saksbehandler
	Sidemannkontr.	Prosjektansvarlig AST
Plankontoret H. Homme AS 4747 Valle Tlf: 37 93 70 00, Fax: 37 93 74 74, E-Post: post@plankontoret.no	Dato 03.12.2009	Målestokk 1: 200
	Prosj.nr. 2219-v1	1: 200
	Tegn.nr. -Tp-30	Rev.

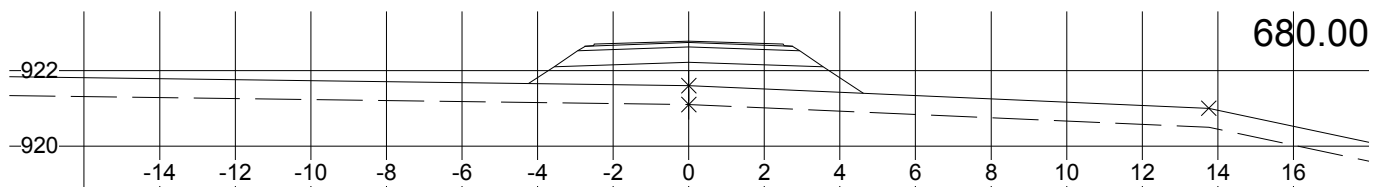
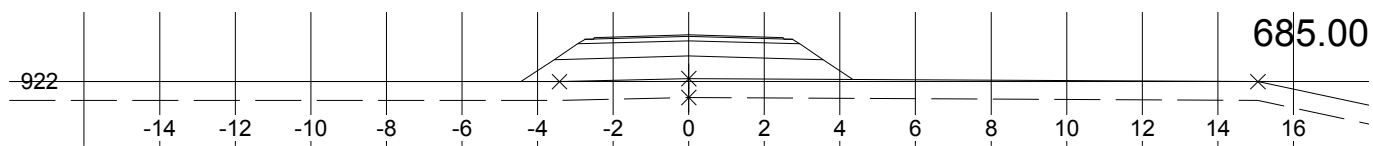
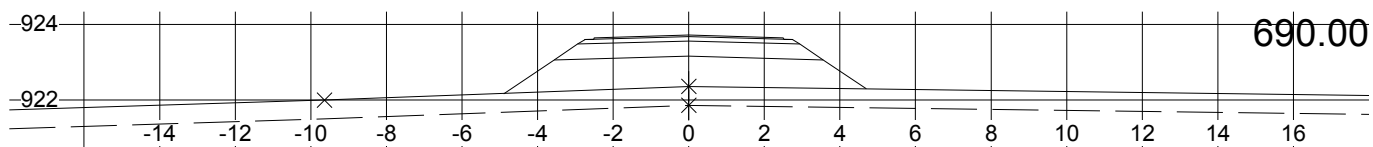
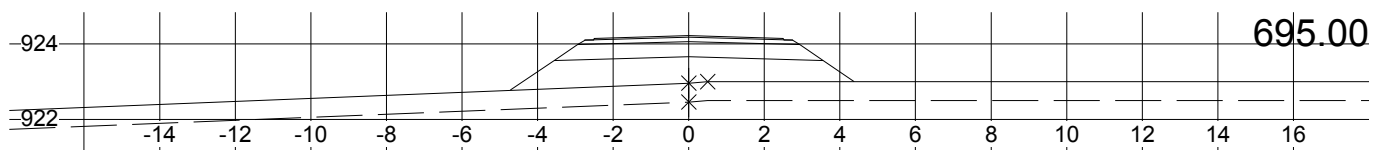
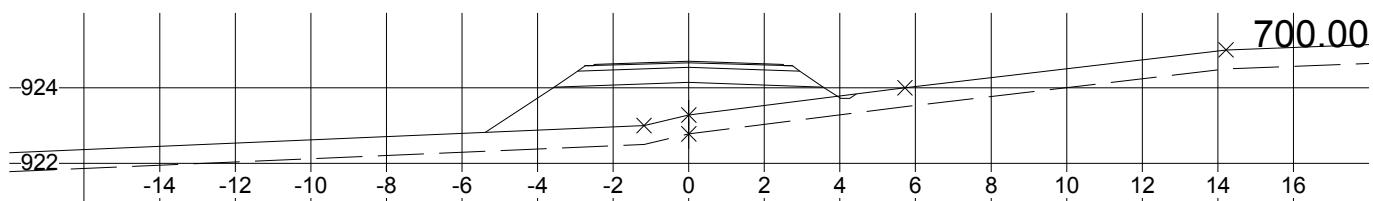
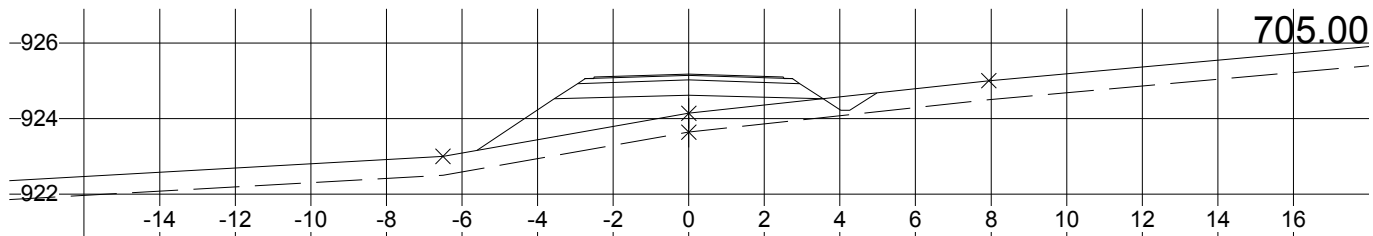

L:\MA 4.7, Lisens: Plankontoret Hallvard Homme AS, Parsell: Parsell1.psl

Rauland Invest AS Holtarvegen Tverrprofil	Tegnet av AST	Saksbehandler
	Sidemannskontr.	Prosjektansvarlig AST
Plankontoret H. Homme AS 4747 Valle Tlf: 37 93 70 00, Fax: 37 93 74 74, E-Post: post@plankontoret.no	Dato 03.12.2009	Målestokk 1: 200
	Prosj.nr. 2219-v1	1: 200
	Tegn.nr. -Tp-31	Rev.

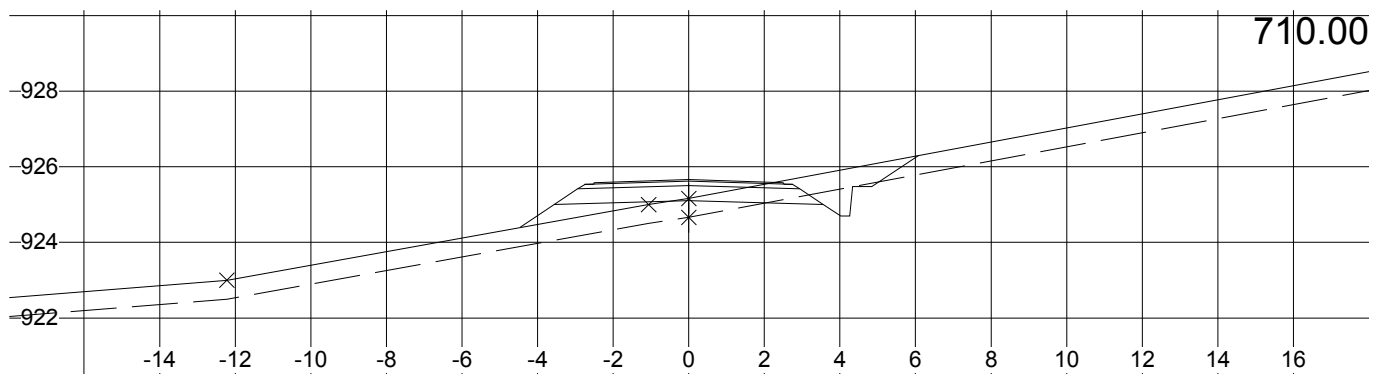
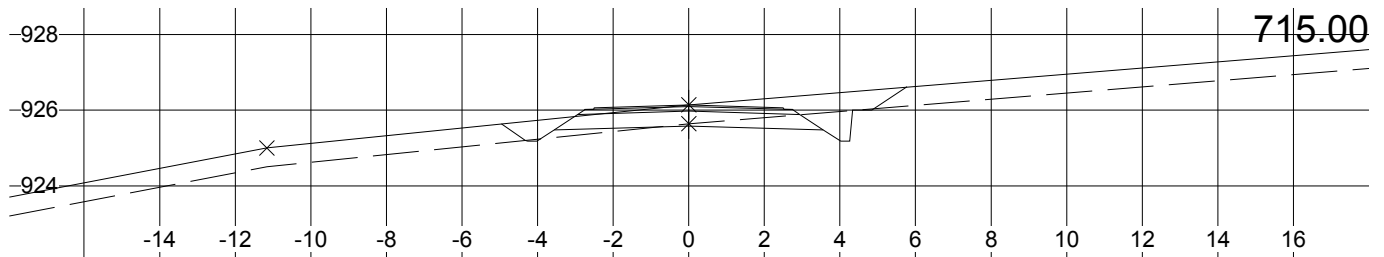
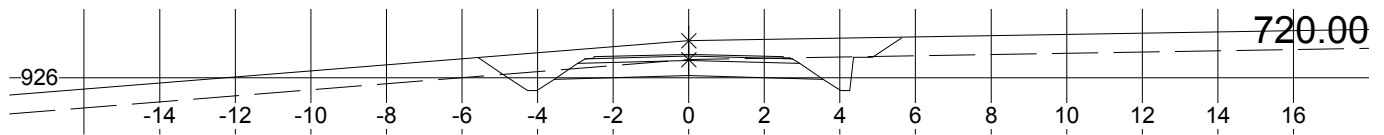
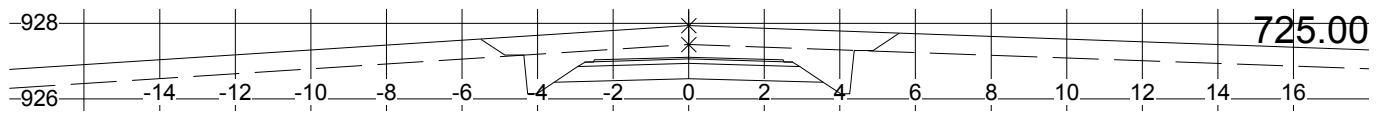
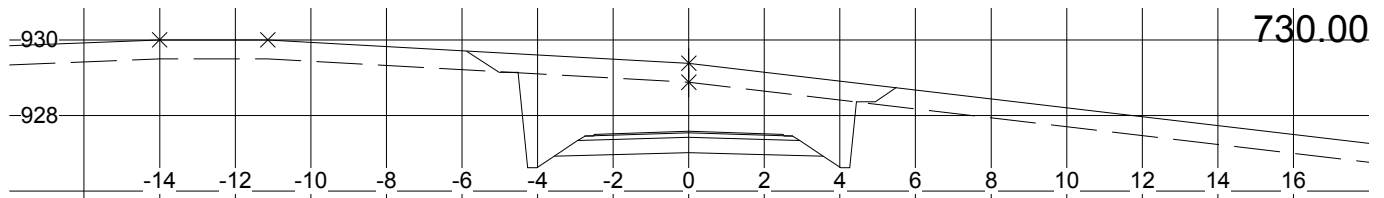
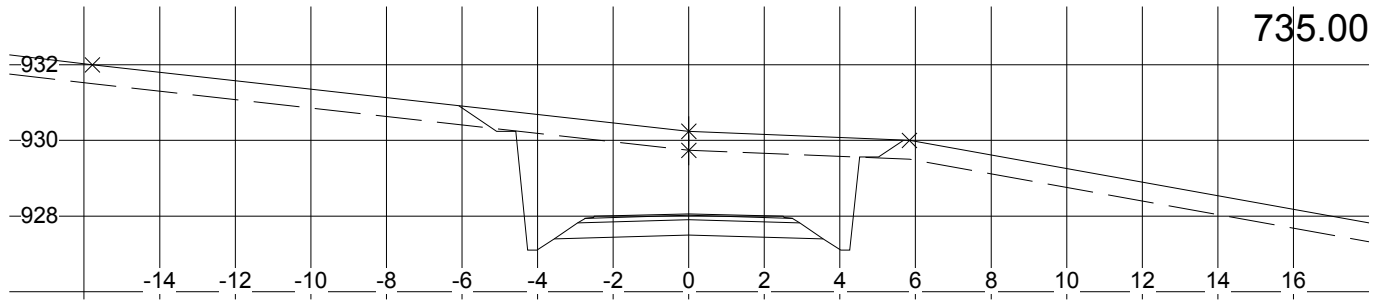

L:\IMA 4.7, Lisens: Plankontoret Hallvard Homme AS, Parsell: Parsell1.psl

Rauland Invest AS Holtarvegen Tverrprofil	Tegnet av AST	Saksbehandler
	Sidemannskontr.	Prosjektansvarlig AST
Plankontoret H. Homme AS 4747 Valle Tlf: 37 93 70 00, Fax: 37 93 74 74, E-Post: post@plankontoret.no	Dato 03.12.2009	Målestokk 1: 200
	Prosj.nr. 2219-v1	1: 200
	Tegn.nr. -Tp-32	Rev.

750.00

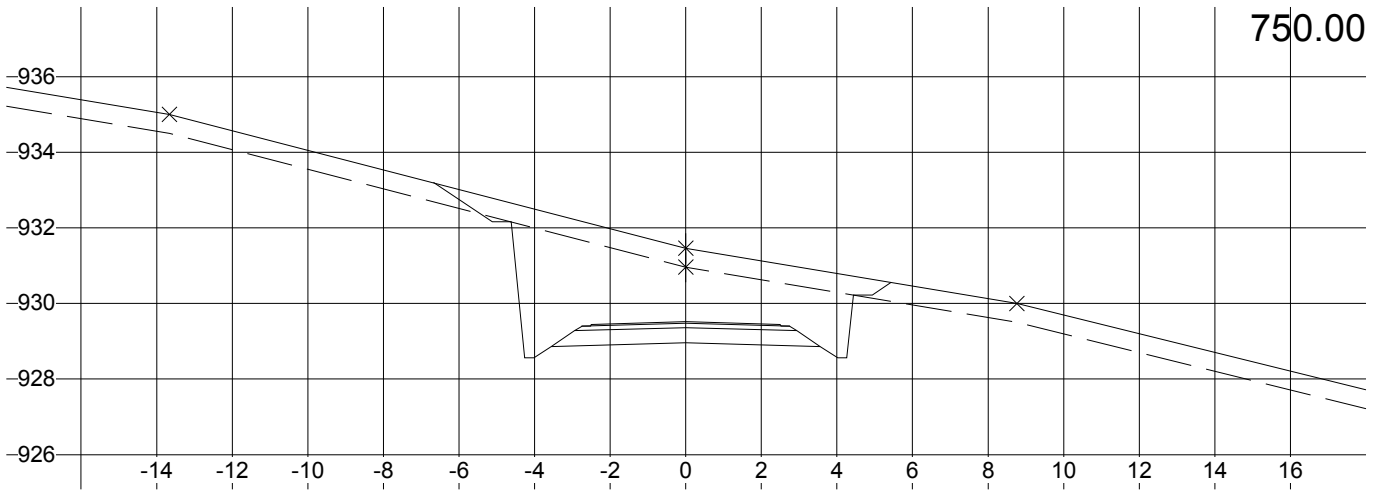

745.00

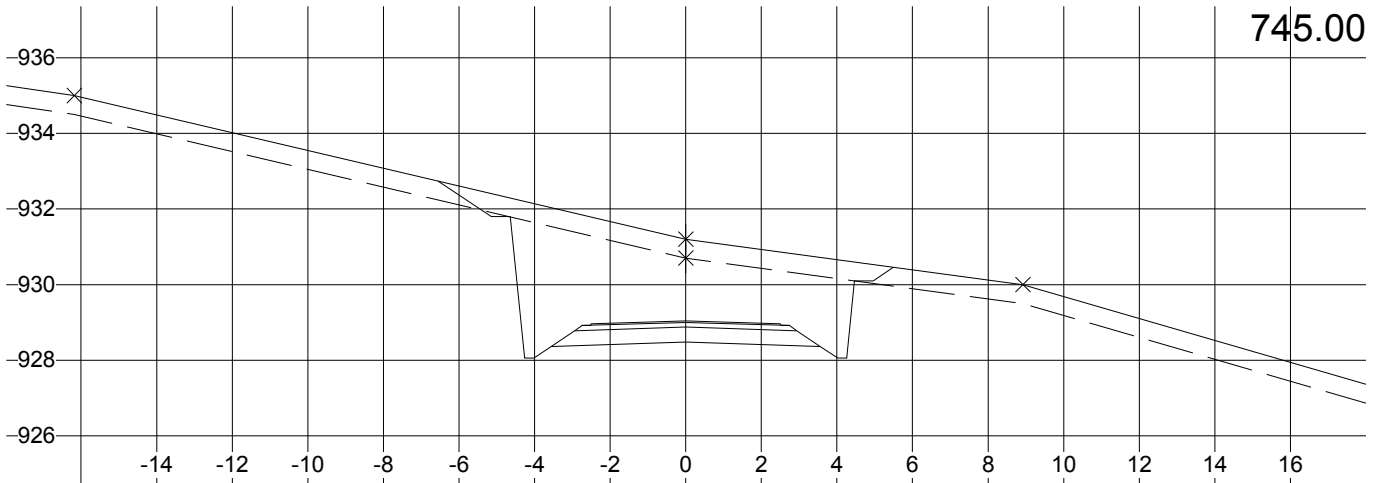

740.00

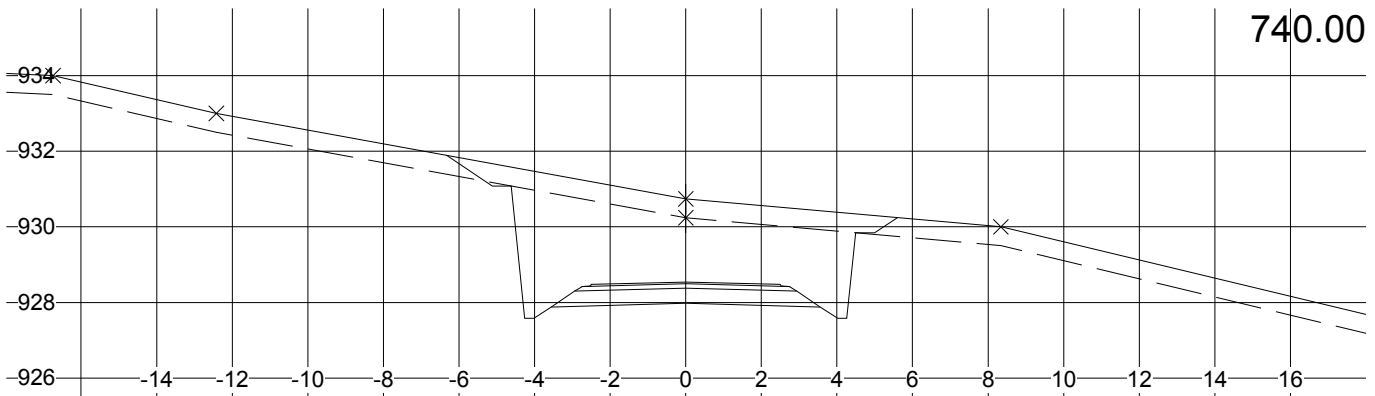

L:\IMA 4.7, Lisens: Plankontoret Hallvard Homme AS, Parsell: Parsell1.psl

Rauland Invest AS Holtarvegen Tverrprofil	Tegnet av AST	Saksbehandler
	Sidemannskontr.	Prosjektansvarlig AST
Plankontoret H. Homme AS 4747 Valle Tlf: 37 93 70 00, Fax: 37 93 74 74, E-Post: post@plankontoret.no	Dato 03.12.2009	Målestokk 1: 200
	Prosj.nr. 2219-v1	1: 200
	Tegn.nr. -Tp-33	Rev.

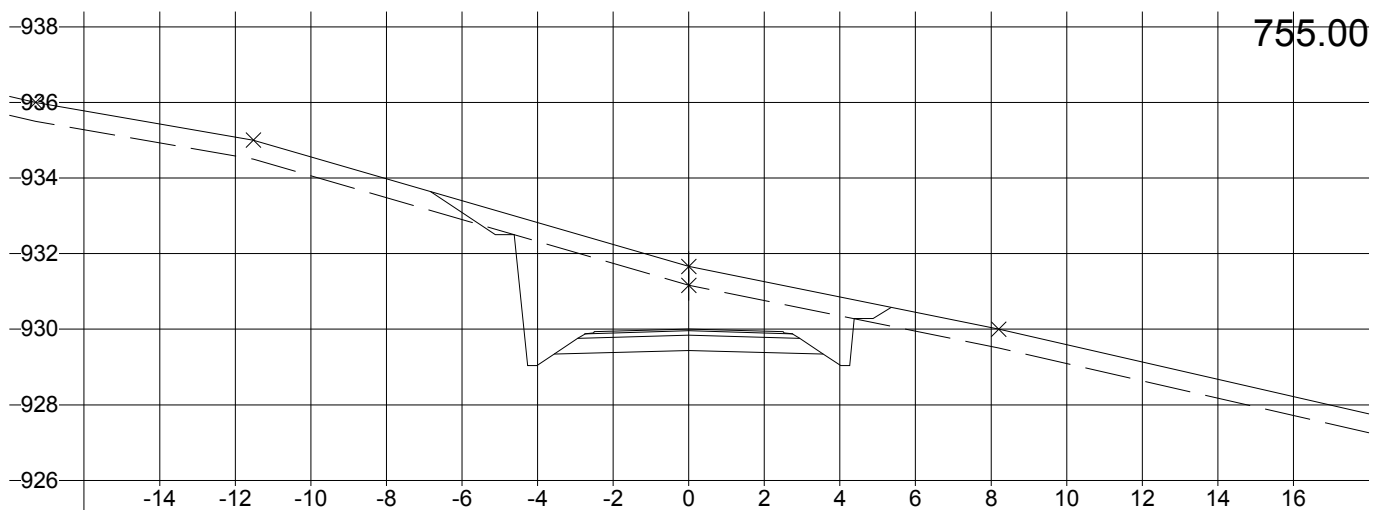
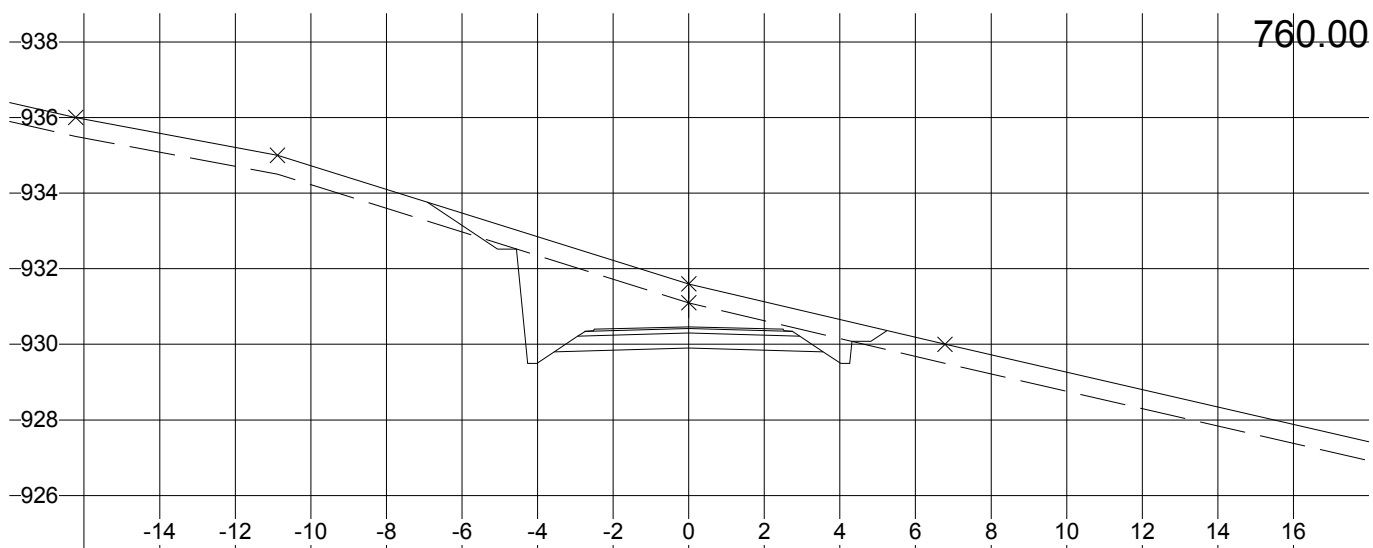

L:\IMA 4.7, Lisens: Plankontoret Hallvard Homme AS, Parsell: Parsell1.psl

Rauland Invest AS Holtarvegen Tverrprofil	Tegnet av AST	Saksbehandler
	Sidemannskontr.	Prosjektansvarlig AST
	Dato 03.12.2009	Målestokk 1: 200
	Prosj.nr. 2219-v1	1: 200
Plankontoret H. Homme AS 4747 Valle Tlf: 37 93 70 00, Fax: 37 93 74 74, E-Post: post@plankontoret.no	Tegn.nr. -Tp-34	Rev.

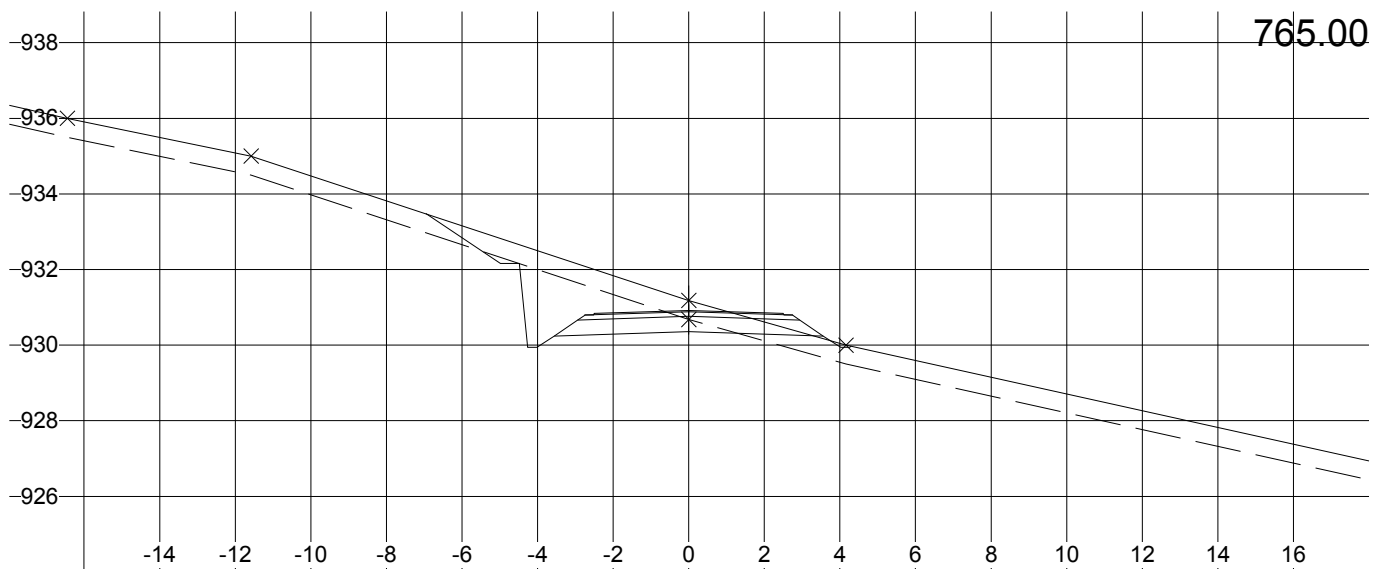
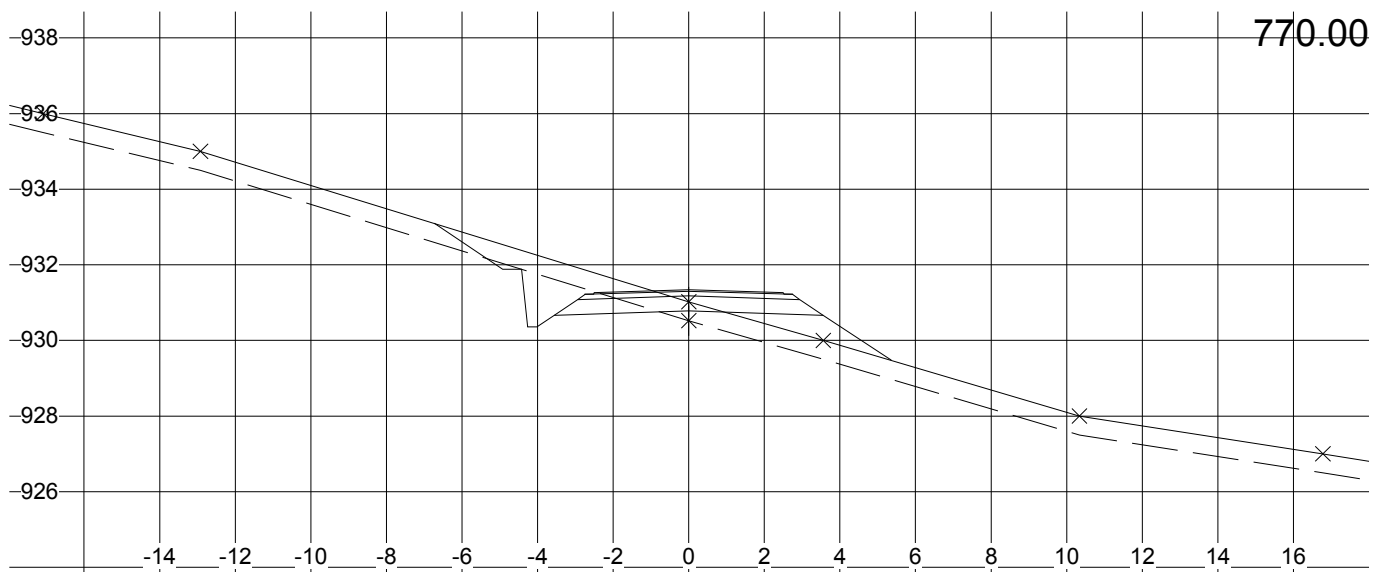

L:\IMA 4.7, Lisens: Plankontoret Hallvard Homme AS, Parsell: Parsell1.psl

Rauland Invest AS Holtarvegen Tverrprofil	Tegnet av AST	Saksbehandler
	Sidemannskontr.	Prosjektansvarlig AST
Plankontoret H. Homme AS 4747 Valle Tlf: 37 93 70 00, Fax: 37 93 74 74, E-Post: post@plankontoret.no	Dato 03.12.2009	Målestokk 1: 200
	Prosj.nr. 2219-v1	1: 200
	Tegn.nr. -Tp-35	Rev.

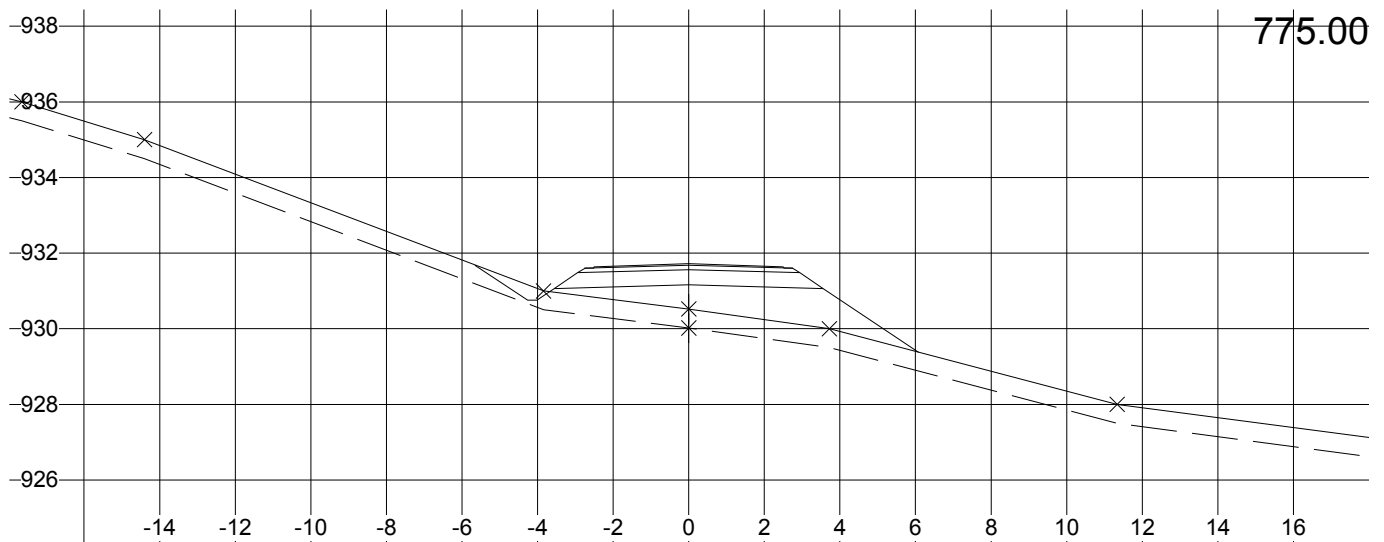
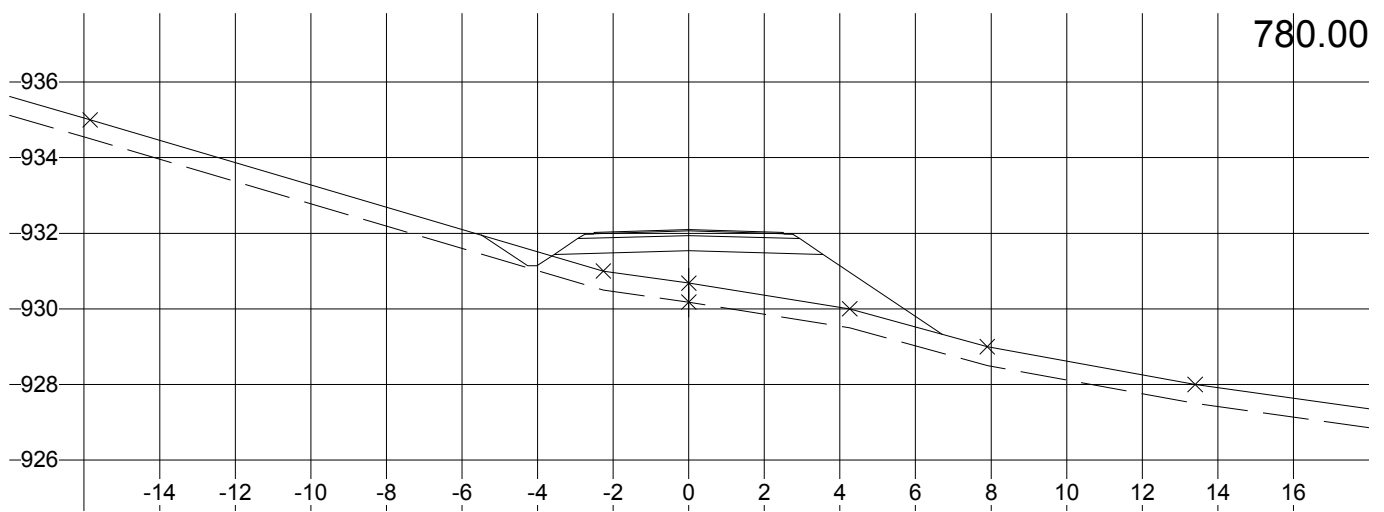
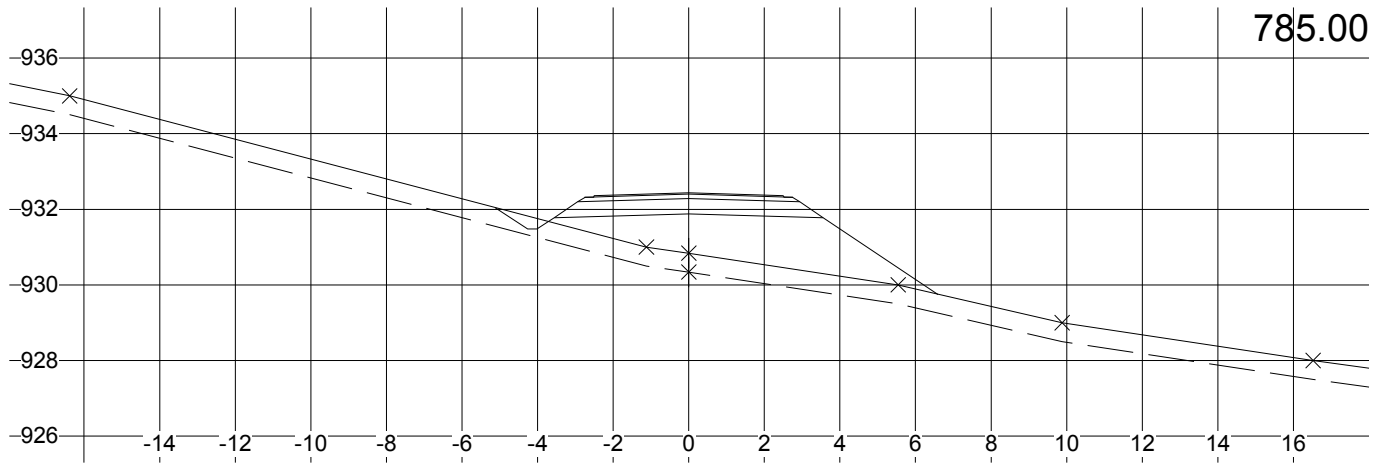

L:\IMA 4.7, Lisens: Plankontoret Hallvard Homme AS, Parsell: Parsell1.ps1

Rauland Invest AS Holtarvegen Tverrprofil	Tegnet av AST	Saksbehandler
	Sidemannskontr.	Prosjektansvarlig AST
	Dato 03.12.2009	Målestokk 1: 200
	Prosj.nr. 2219-v1	1: 200
Plankontoret H. Homme AS 4747 Valle Tlf: 37 93 70 00, Fax: 37 93 74 74, E-Post: post@plankontoret.no	Tegn.nr. -Tp-36	Rev.

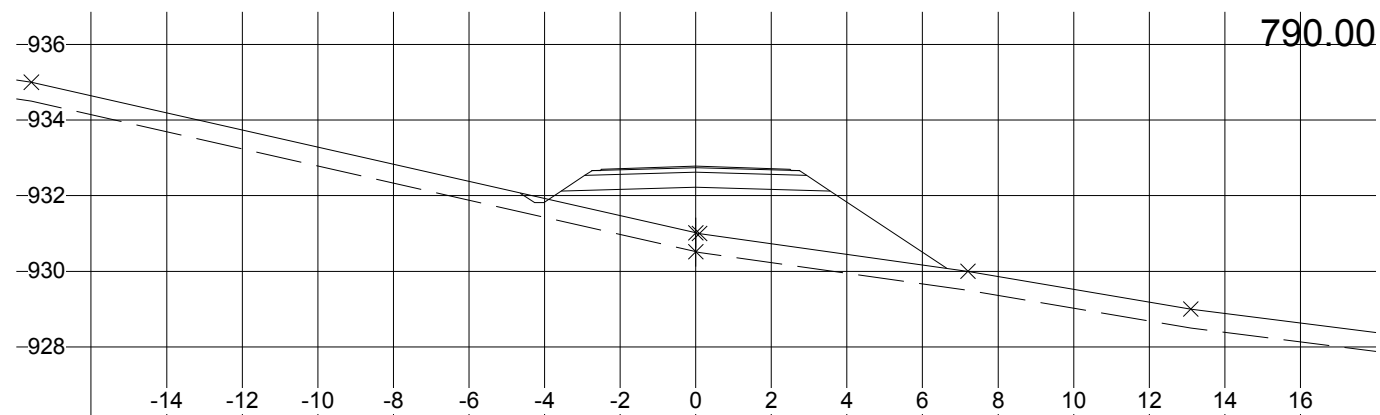
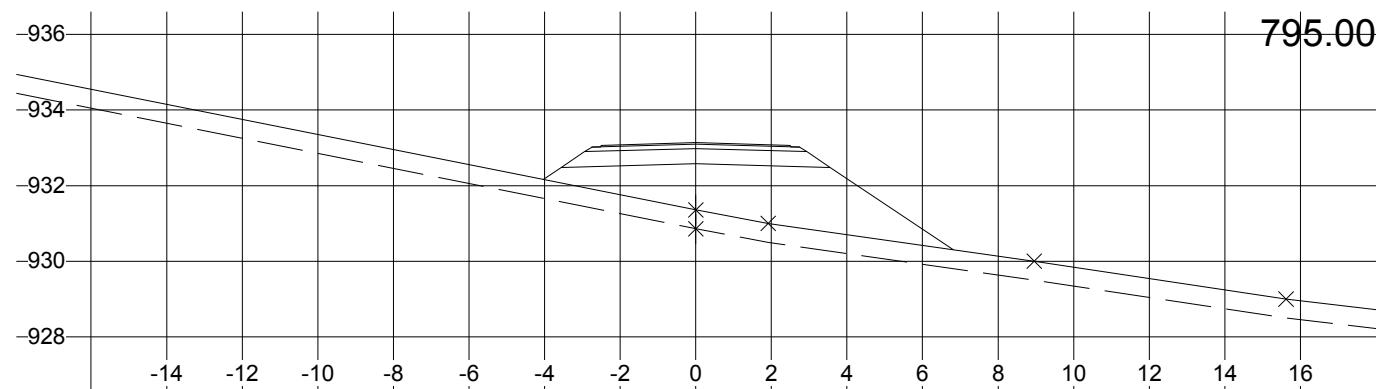
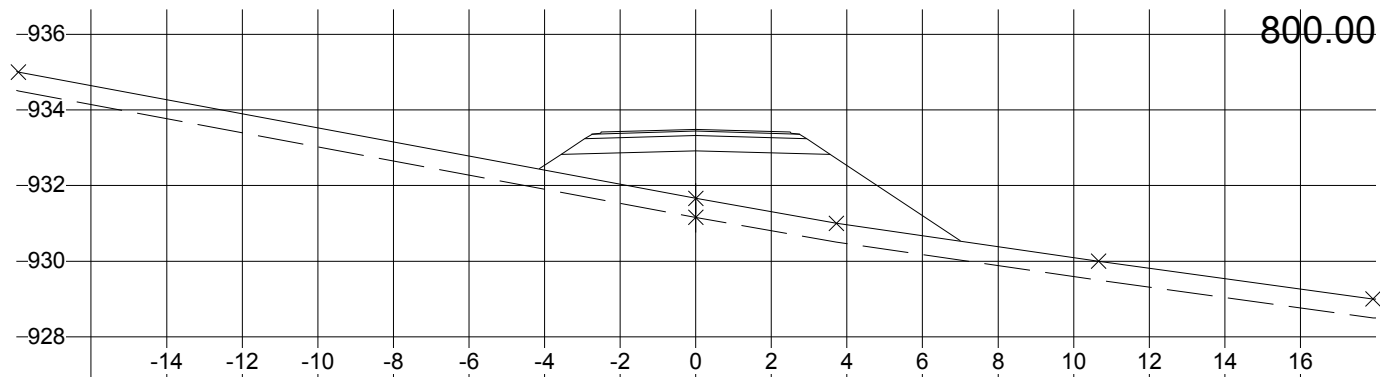

L:\IMA 4.7, Lisens: Plankontoret Hallvard Homme AS, Parsell: Parsell1.psl

Rauland Invest AS Holtarvegen Tverrprofil	Tegnet av AST	Saksbehandler
	Sidemannskontr.	Prosjektansvarlig AST
Plankontoret H. Homme AS 4747 Valle Tlf: 37 93 70 00, Fax: 37 93 74 74, E-Post: post@plankontoret.no	Dato 03.12.2009	Målestokk 1: 200
	Prosj.nr. 2219-v1	1: 200
	Tegn.nr. -Tp-37	Rev.

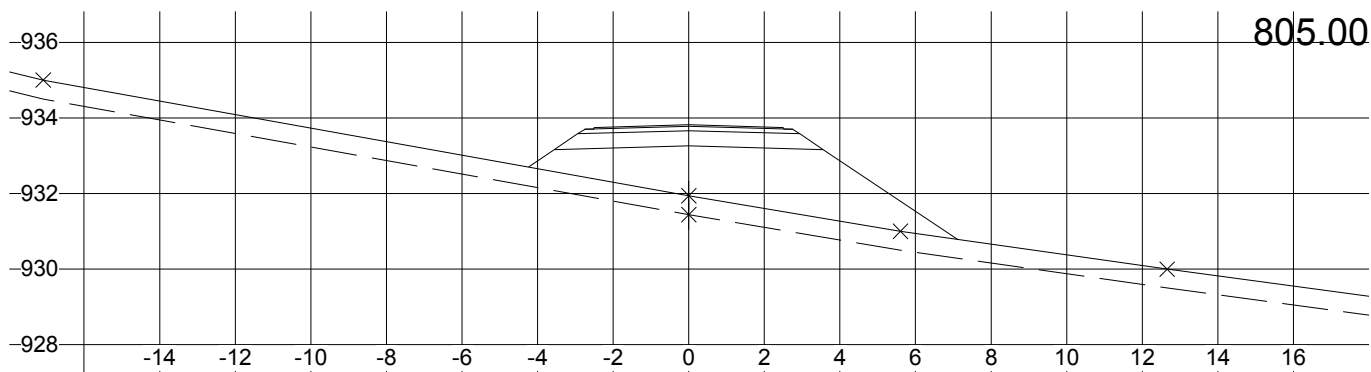
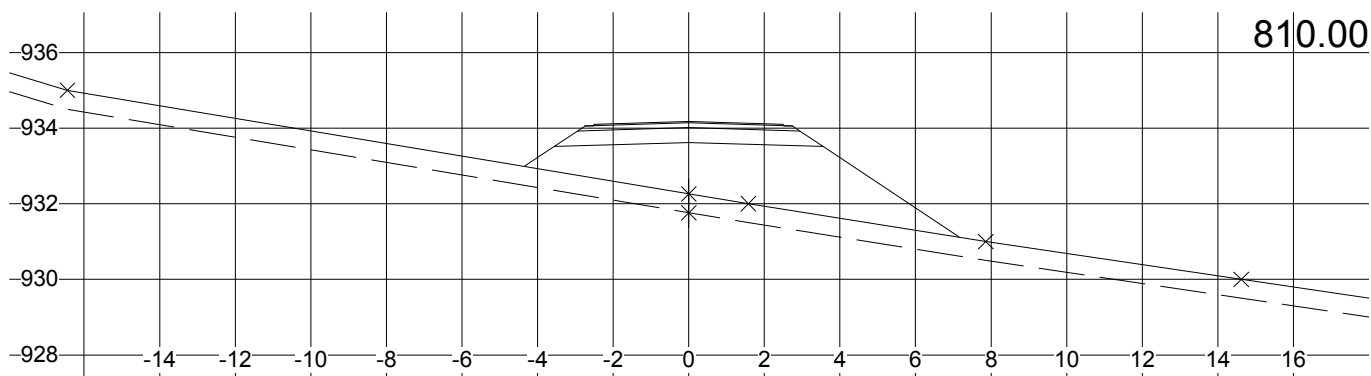
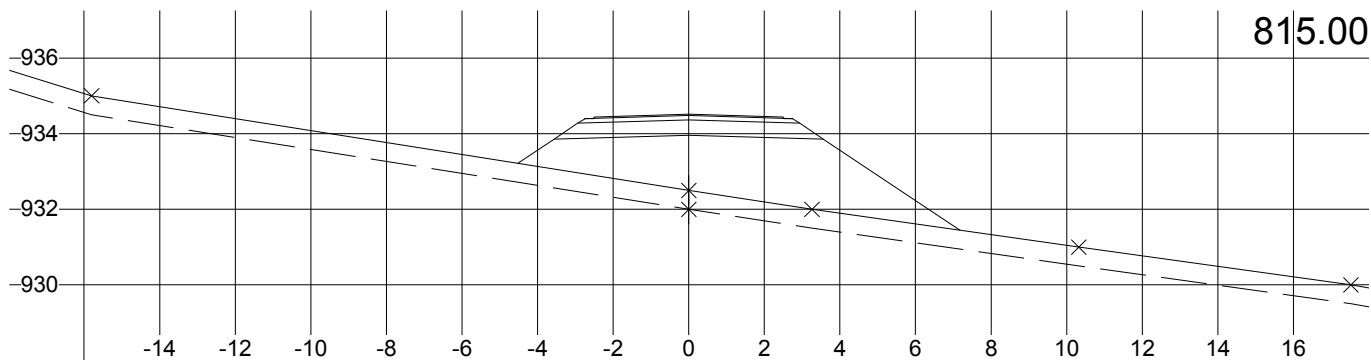
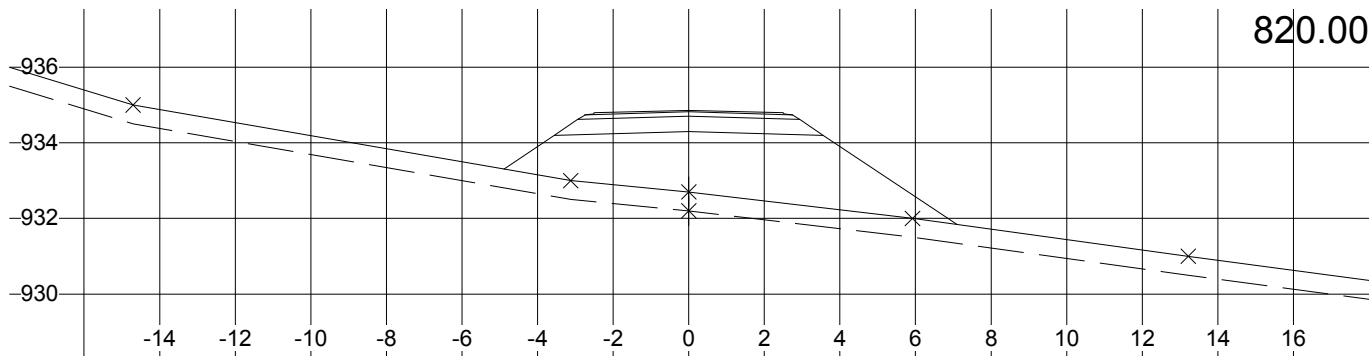

L:\IMA 4.7, Lisens: Plankontoret Hallvard Homme AS, Parsell: Parsell1.psl

Rauland Invest AS Holtarvegen Tverrprofil	Tegnet av AST	Saksbehandler
	Sidemannskontr.	Prosjektansvarlig AST
Plankontoret H. Homme AS 4747 Valle Tlf: 37 93 70 00, Fax: 37 93 74 74, E-Post: post@plankontoret.no	Dato 03.12.2009	Målestokk 1: 200
	Prosj.nr. 2219-v1	1: 200
	Tegn.nr. -Tp-38	Rev.

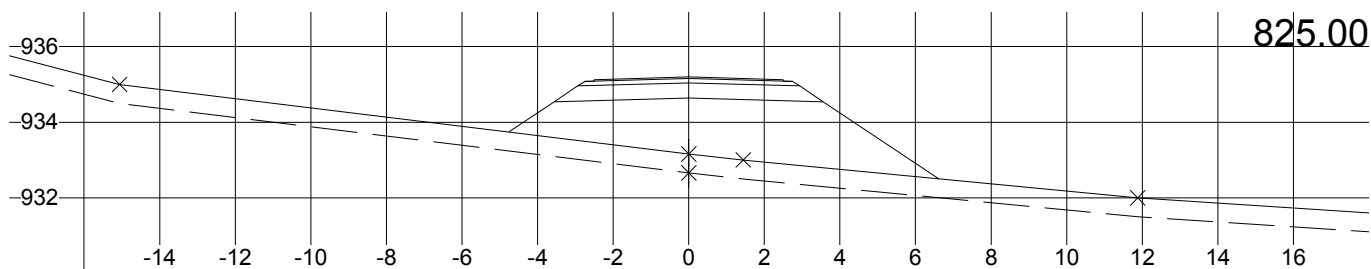
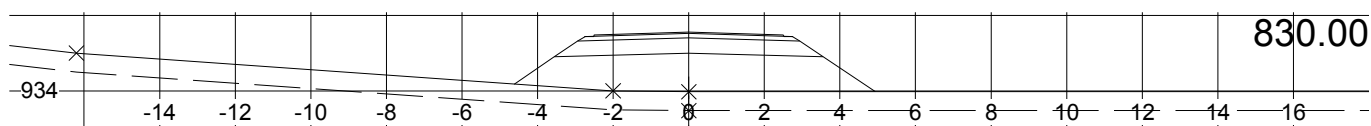
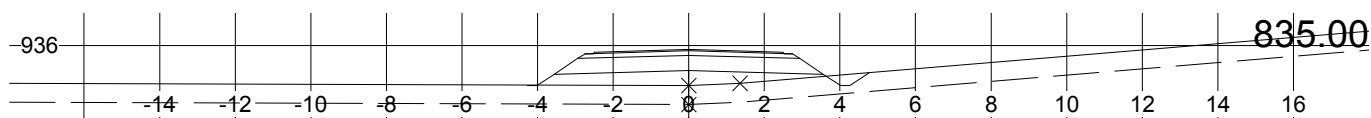
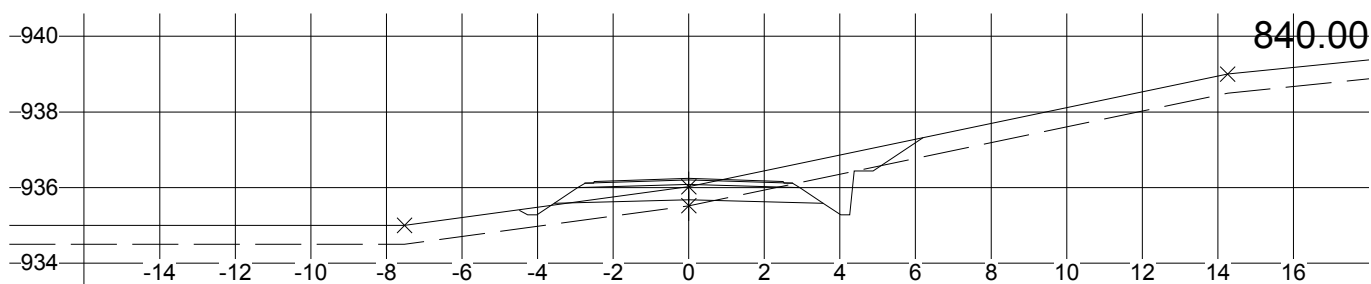
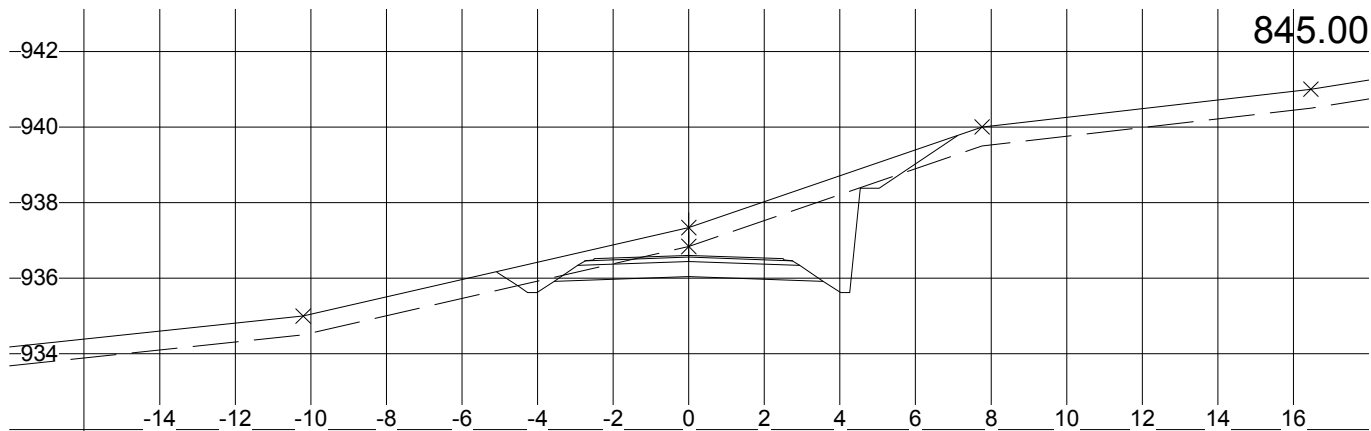

LIMA 4.7, Lisens: Plankontoret Hallvard Homme AS, Parsell: Parsell1.psl

Rauland Invest AS Holtarvegen Tverrprofil	Tegnet av AST	Saksbehandler
	Sidemannskontr.	Prosjektansvarlig AST
Plankontoret H. Homme AS 4747 Valle Tlf: 37 93 70 00, Fax: 37 93 74 74, E-Post: post@plankontoret.no	Dato 03.12.2009	Målestokk 1: 200 1: 200
	Prosj.nr. 2219-v1	
	Tegn.nr. -Tp-39	Rev.

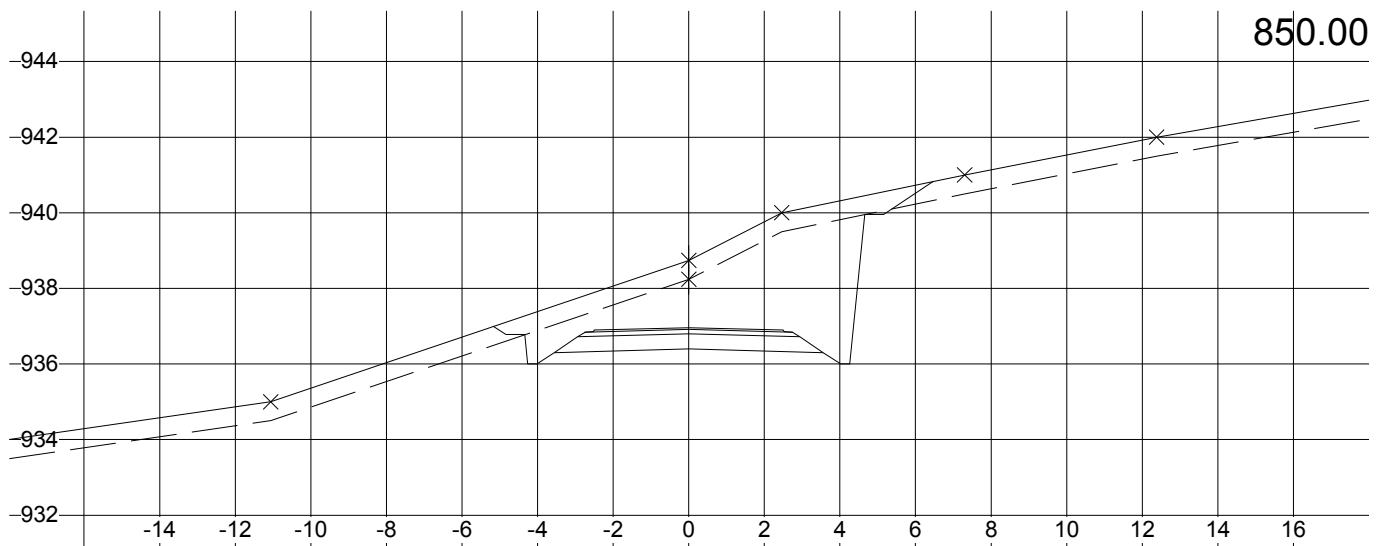
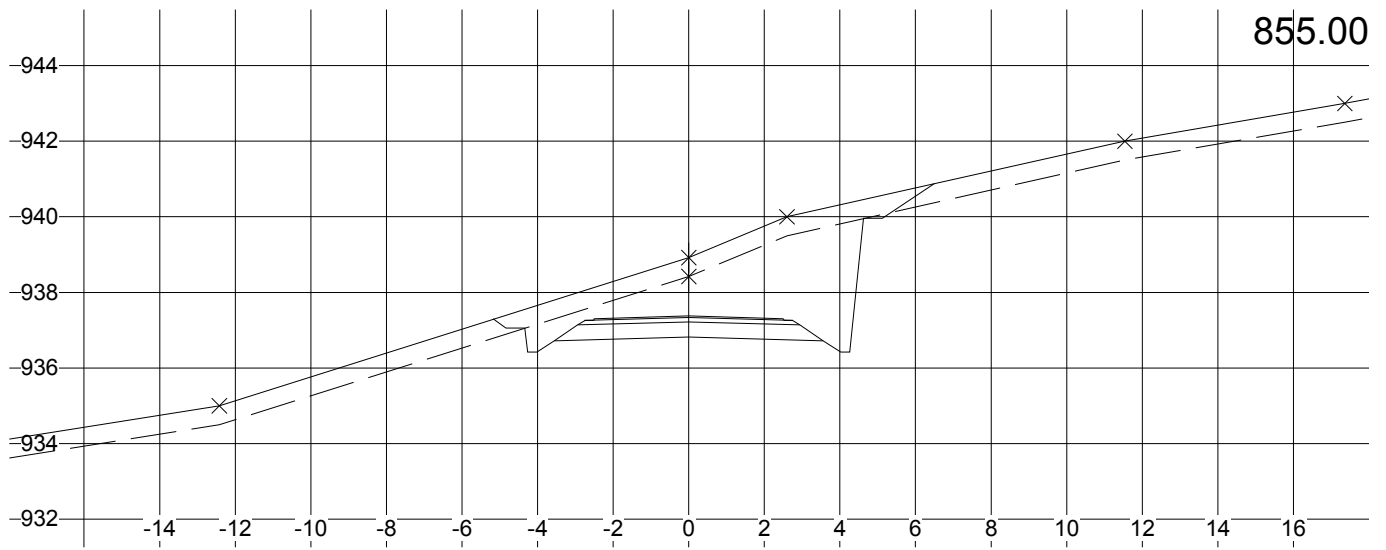

Rauland Invest AS Holtarvegen Tverrprofil	Tegnet av AST	Saksbehandler
	Sidemannskontr.	Prosjektansvarlig AST
Plankontoret H. Homme AS 4747 Valle Tlf: 37 93 70 00, Fax: 37 93 74 74, E-Post: post@plankontoret.no	Dato 03.12.2009	Målestokk 1: 200
	Prosj.nr. 2219-v1	1: 200
	Tegn.nr. -Tp-40	Rev.

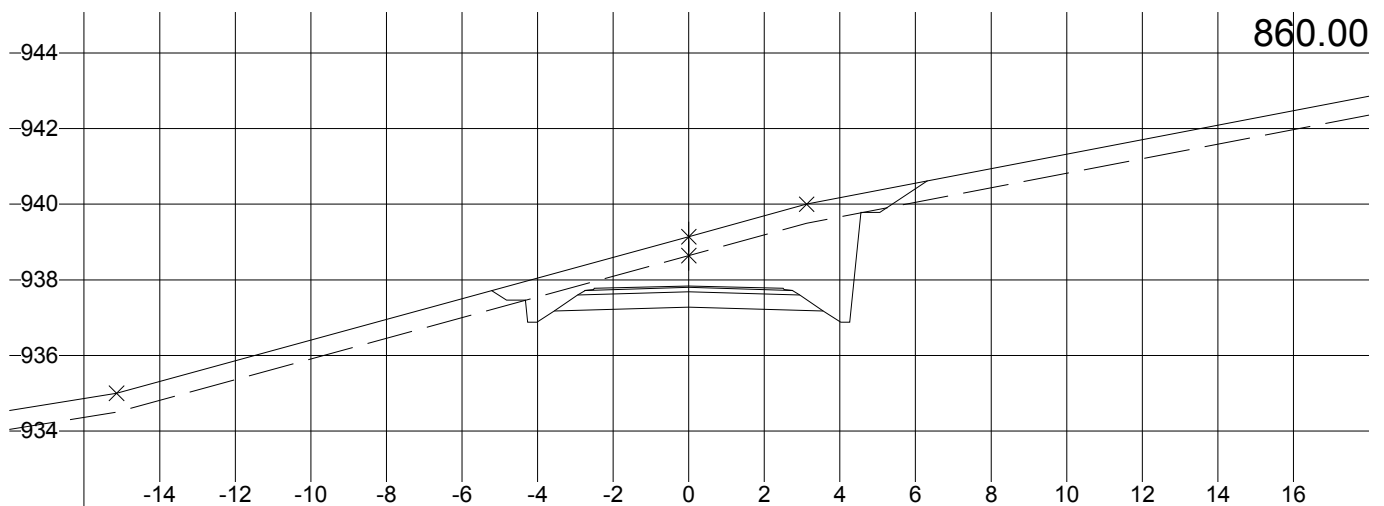
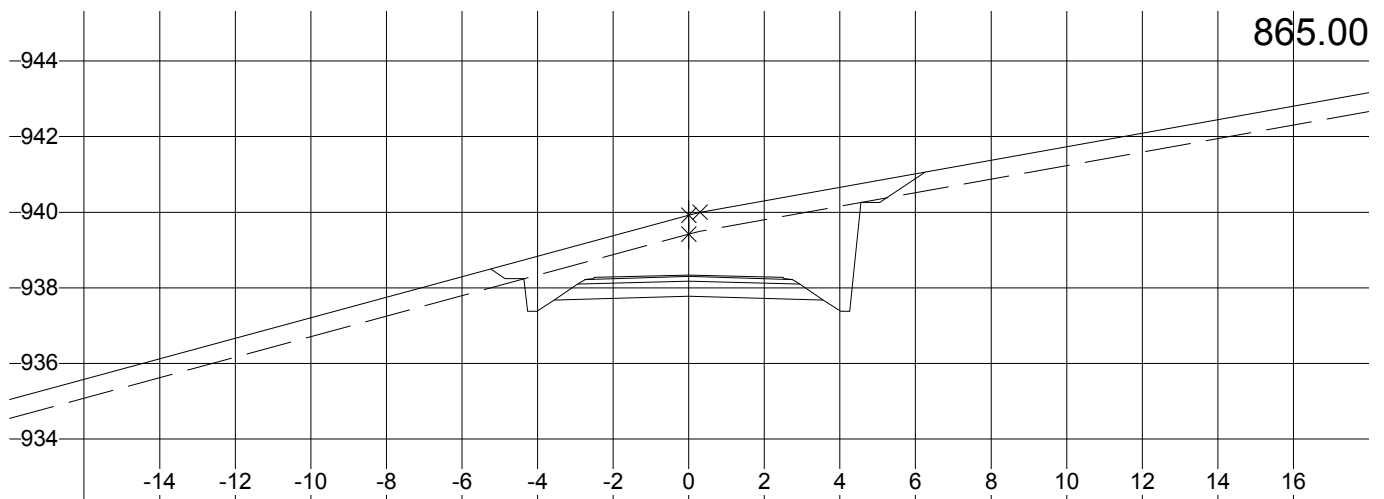
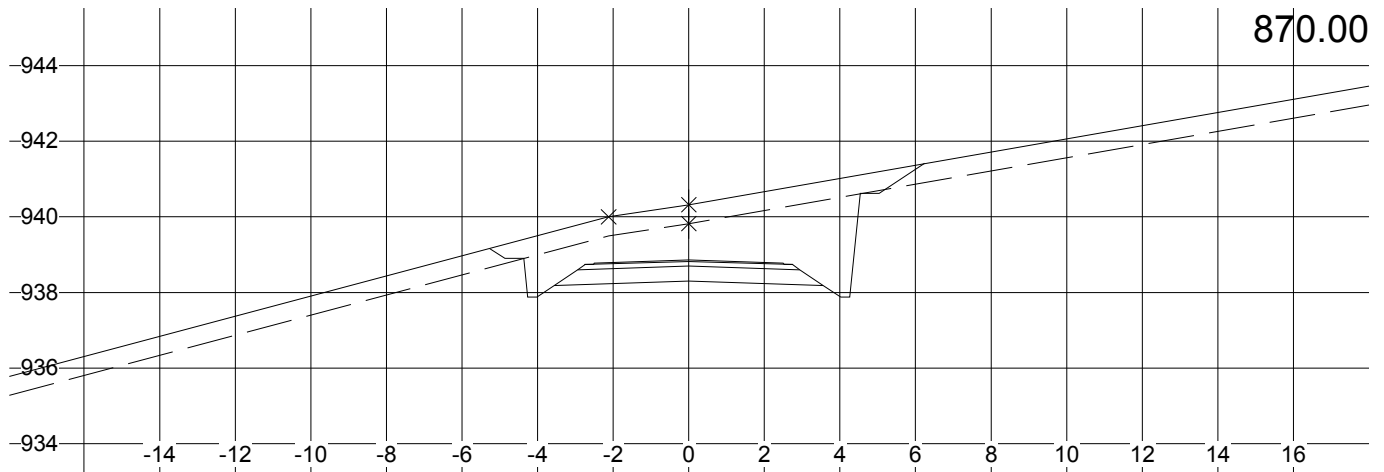

L:\IMA 4.7, Lisens: Plankontoret Hallvard Homme AS, Parsell: Parsell1.psl

Rauland Invest AS Holtarvegen Tverrprofil	Tegnet av AST	Saksbehandler
	Sidemannskontr.	Prosjektansvarlig AST
Plankontoret H. Homme AS 4747 Valle Tlf: 37 93 70 00, Fax: 37 93 74 74, E-Post: post@plankontoret.no	Dato 03.12.2009	Målestokk 1: 200
	Prosj.nr. 2219-v1	1: 200
	Tegn.nr. -Tp-41	Rev.

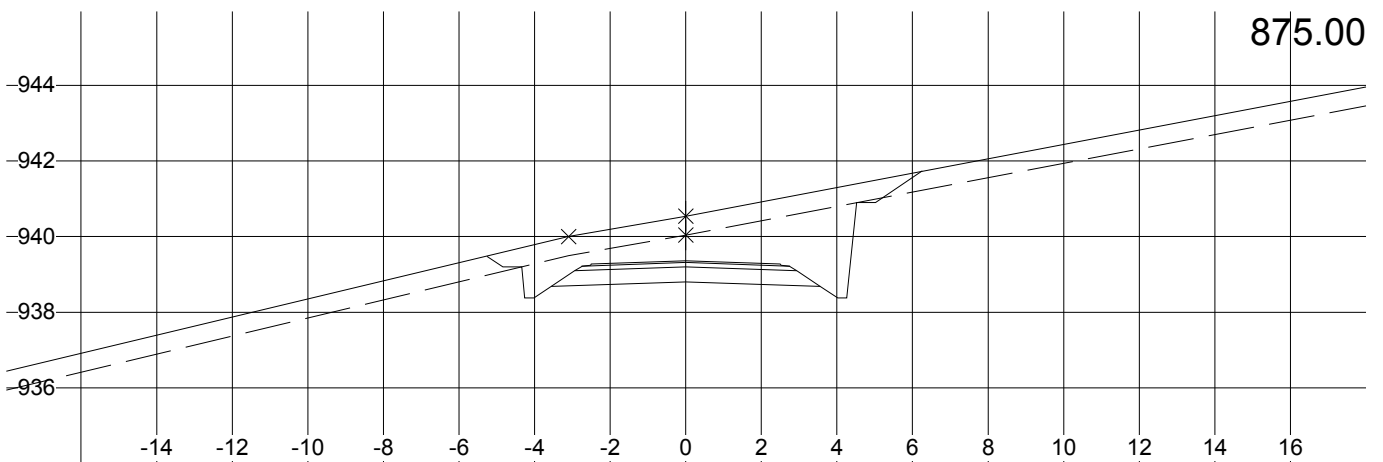
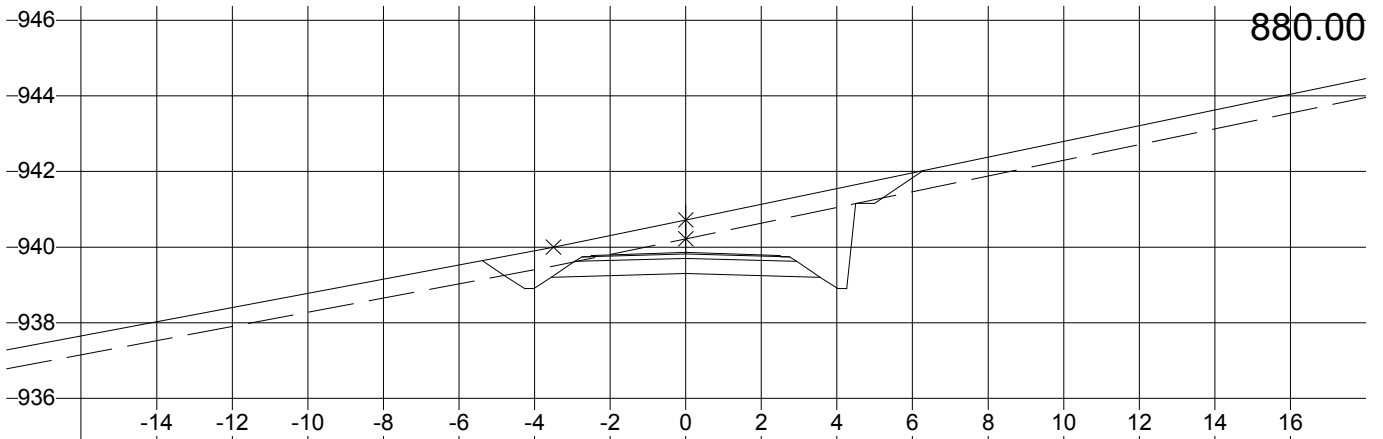
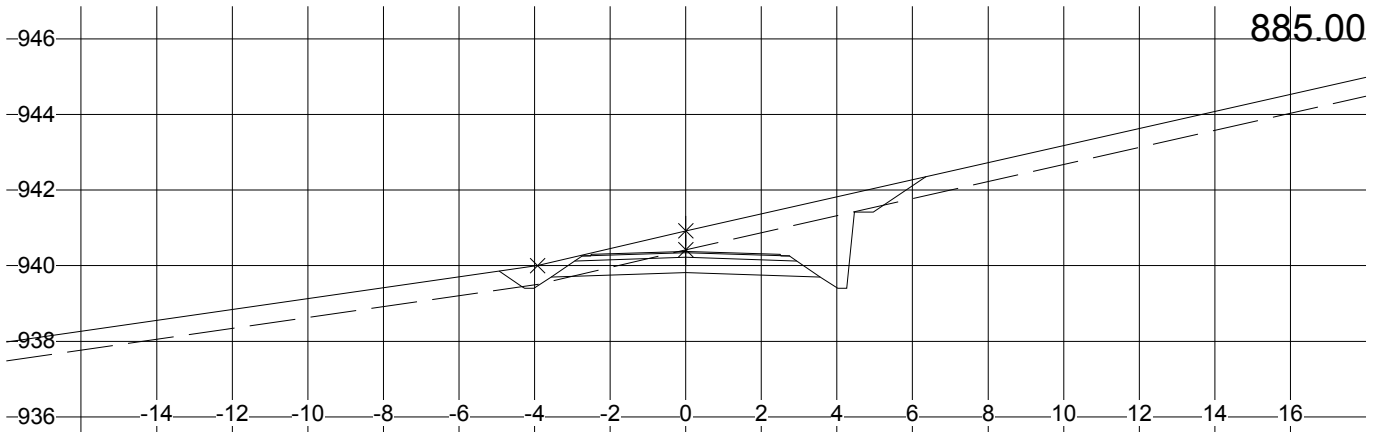

L:\IMA 4.7, Lisens: Plankontoret Hallvard Homme AS, Parsell: Parsell1.psl

Rauland Invest AS Holtarvegen Tverrprofil	Tegnet av AST	Saksbehandler
	Sidemannskontr.	Prosjektansvarlig AST
Plankontoret H. Homme AS 4747 Valle Tlf: 37 93 70 00, Fax: 37 93 74 74, E-Post: post@plankontoret.no	Dato 03.12.2009	Målestokk 1: 200
	Prosj.nr. 2219-v1	1: 200
	Tegn.nr. -Tp-42	Rev.

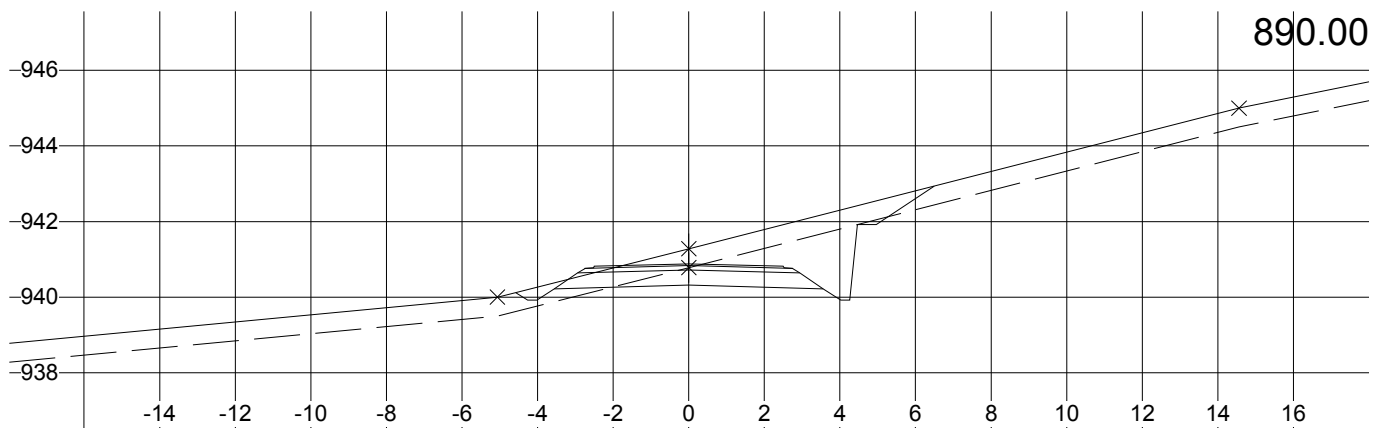
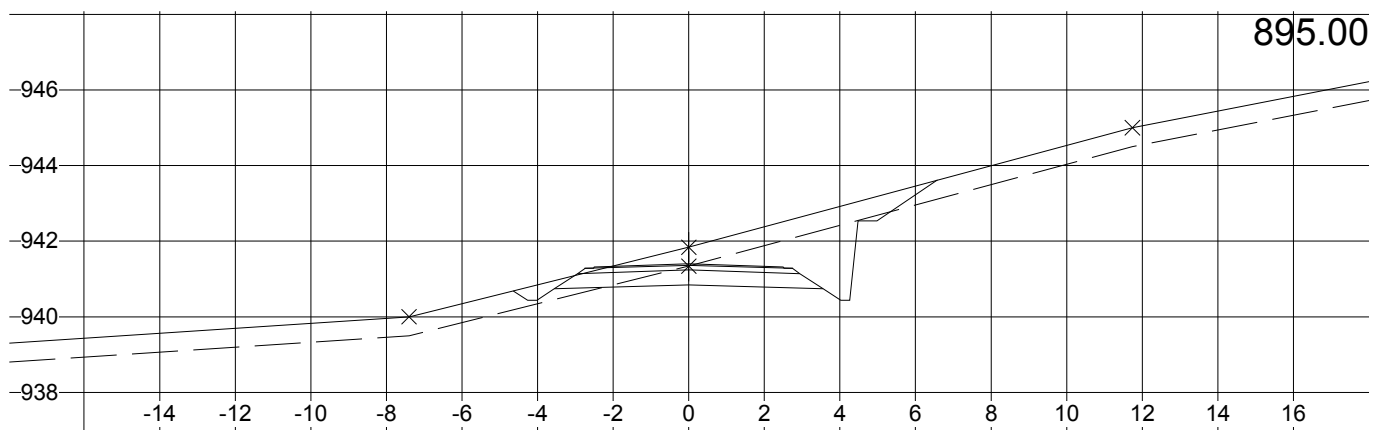
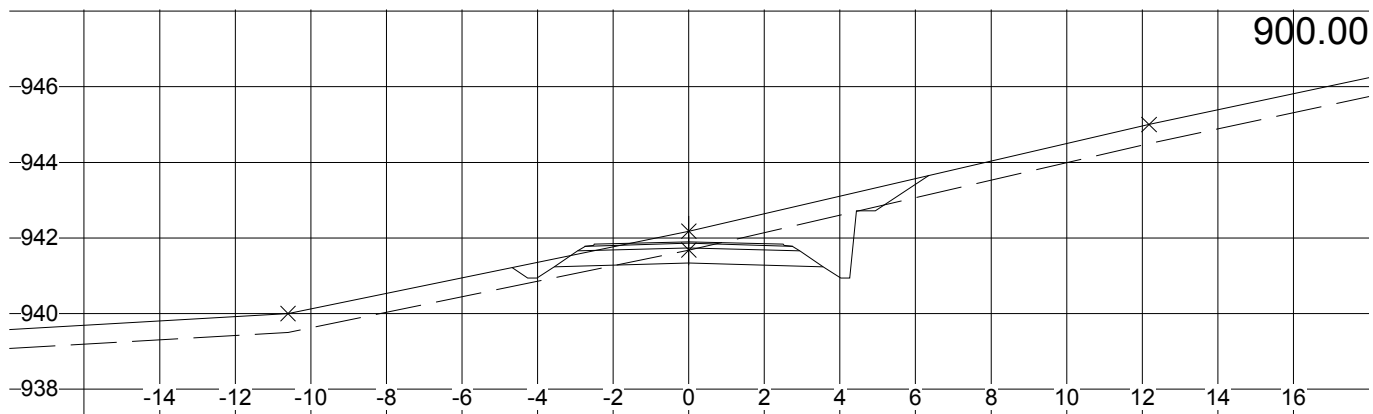

L:\IMA 4.7, Lisens: Plankontoret Hallvard Homme AS, Parsell: Parsell1,psl

Rauland Invest AS Holtarvegen Tverrprofil	Tegnet av AST	Saksbehandler
	Sidemannskontr.	Prosjektansvarlig AST
Plankontoret H. Homme AS 4747 Valle Tlf: 37 93 70 00, Fax: 37 93 74 74, E-Post: post@plankontoret.no	Dato 03.12.2009	Målestokk 1: 200
	Prosj.nr. 2219-v1	1: 200
	Tegn.nr. -Tp-43	Rev.

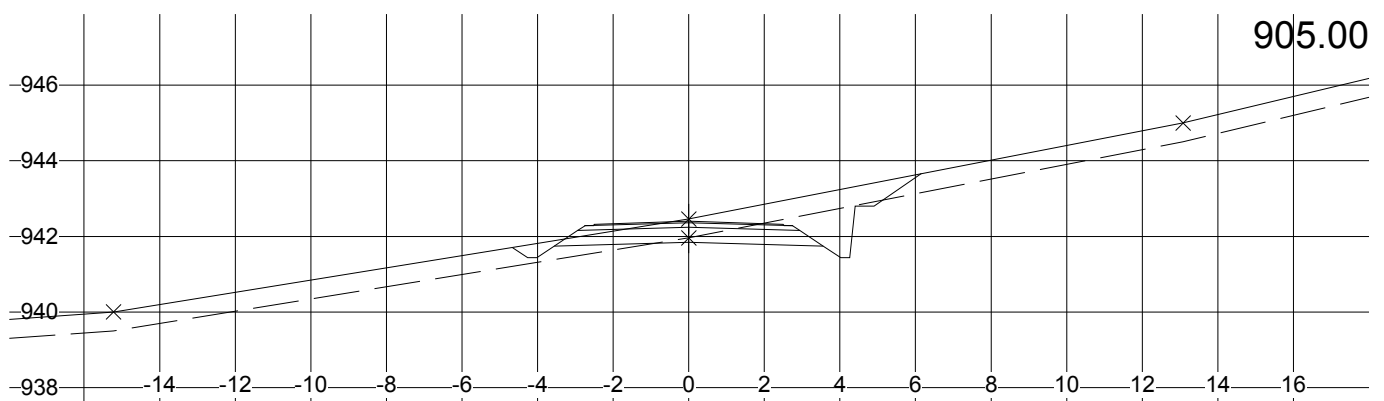
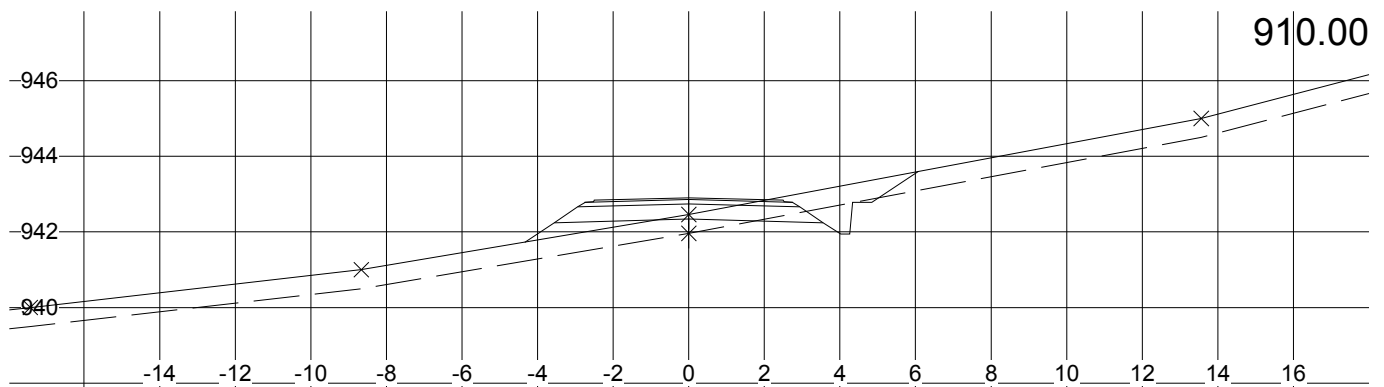
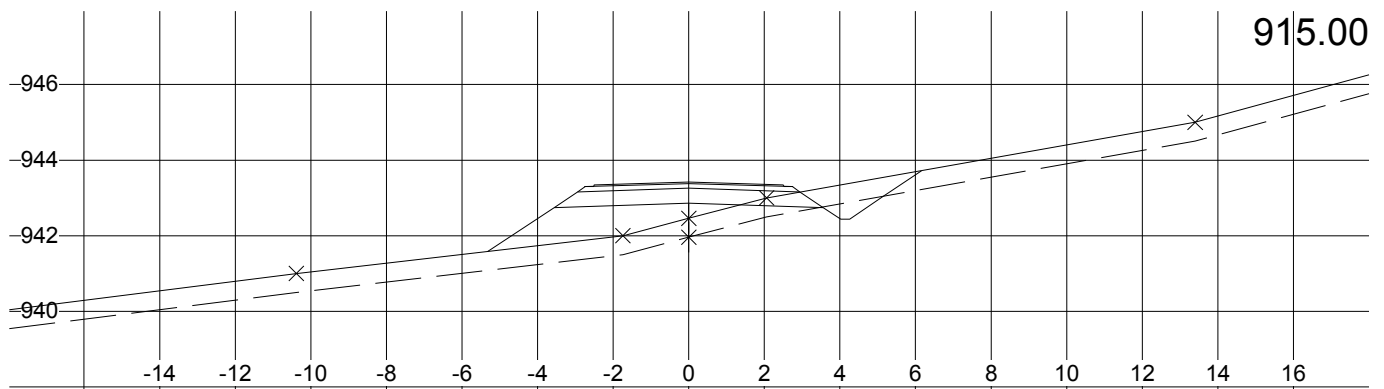

L:\IMA 4.7, Lisens: Plankontoret Hallvard Homme AS, Parsell: Parsell1,psl

Rauland Invest AS Holtarvegen Tverrprofil	Tegnet av AST	Saksbehandler
	Sidemannskontr.	Prosjektansvarlig AST
Plankontoret H. Homme AS 4747 Valle Tlf: 37 93 70 00, Fax: 37 93 74 74, E-Post: post@plankontoret.no	Dato 03.12.2009	Målestokk 1: 200
	Prosj.nr. 2219-v1	1: 200
	Tegn.nr. -Tp-44	Rev.

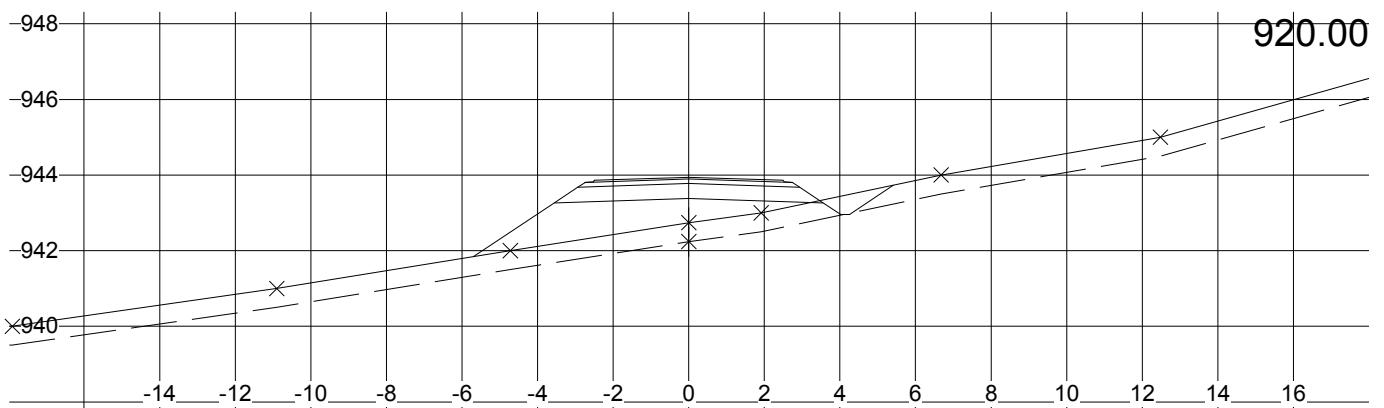
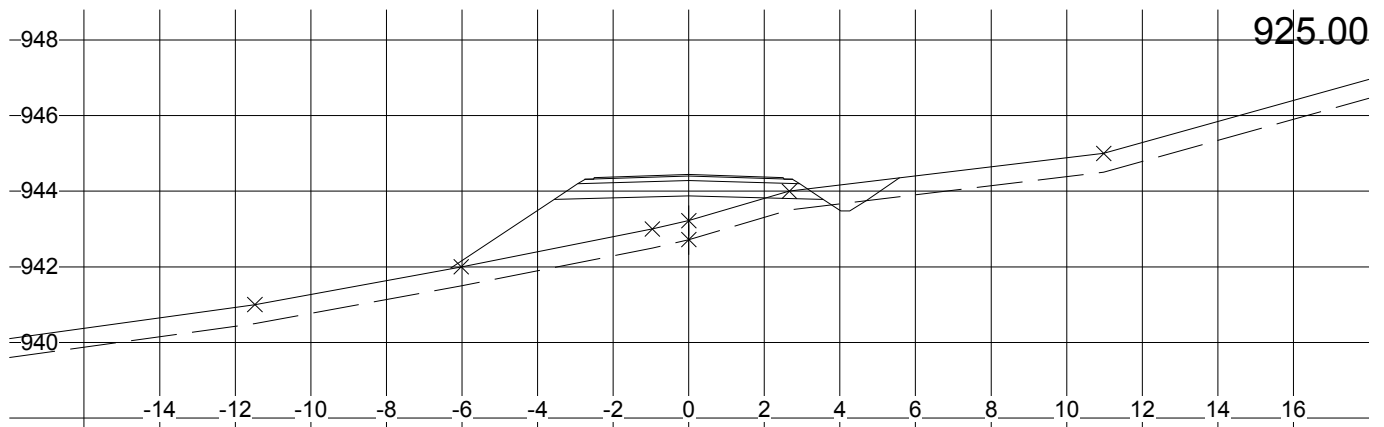
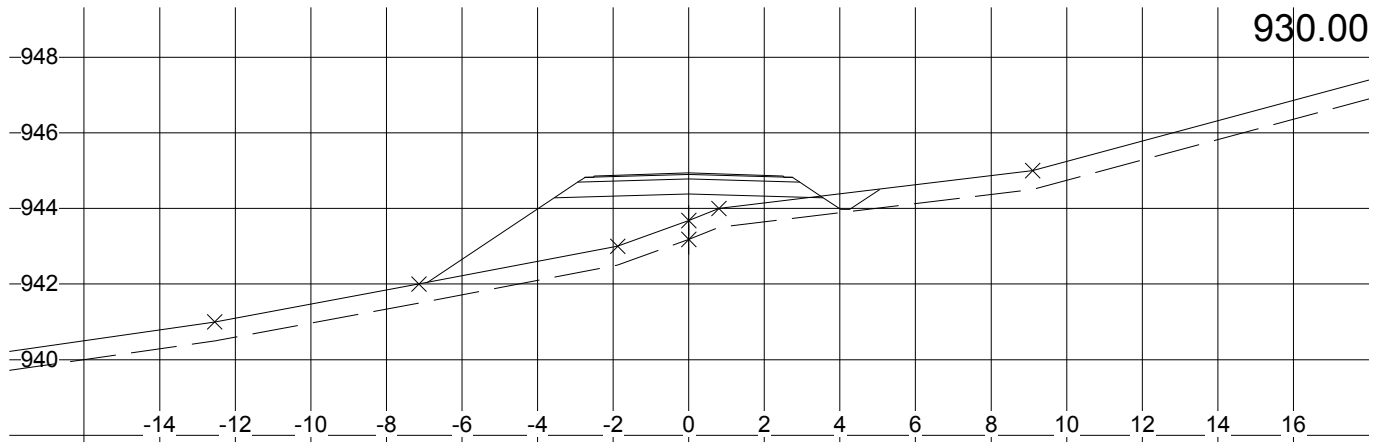

L:\IMA 4.7, Lisens: Plankontoret Hallvard Homme AS, Parsell: Parsell1.psl

Rauland Invest AS Holtarvegen Tverrprofil	Tegnet av AST	Saksbehandler
	Sidemannskontr.	Prosjektansvarlig AST
Plankontoret H. Homme AS 4747 Valle Tlf: 37 93 70 00, Fax: 37 93 74 74, E-Post: post@plankontoret.no	Dato 03.12.2009	Målestokk 1: 200
	Prosj.nr. 2219-v1	1: 200
	Tegn.nr. -Tp-45	Rev.

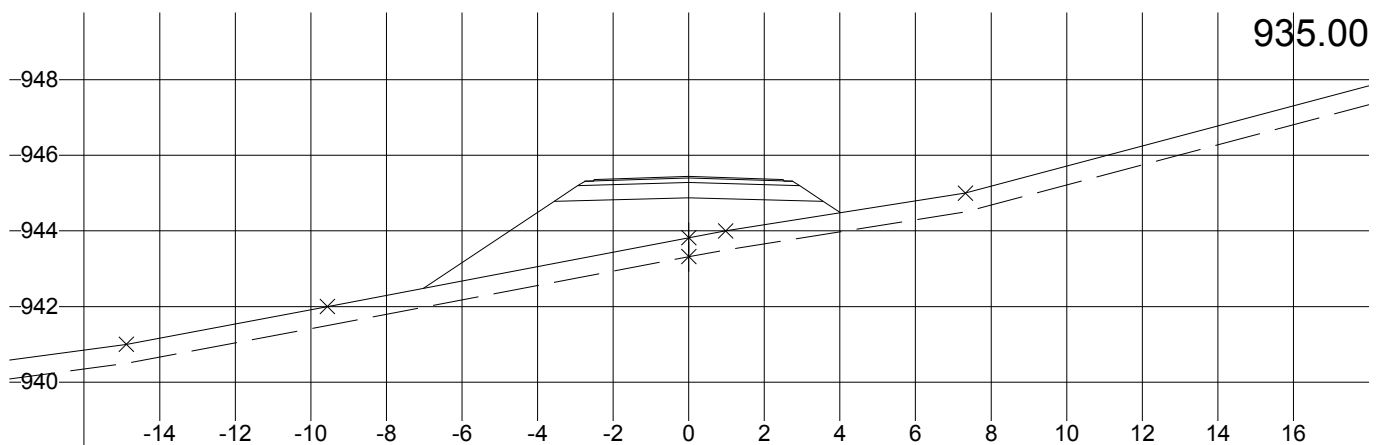
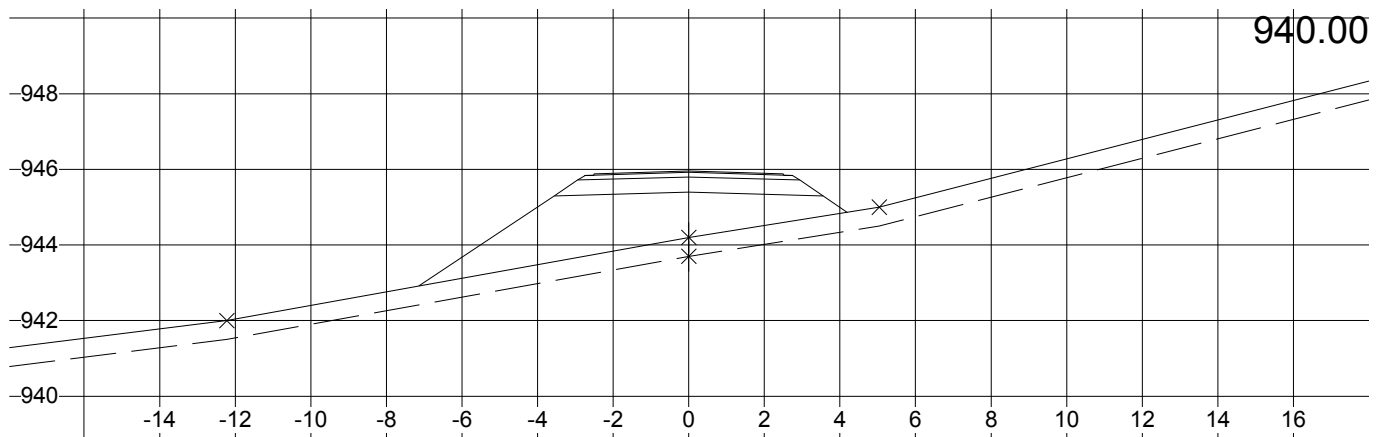
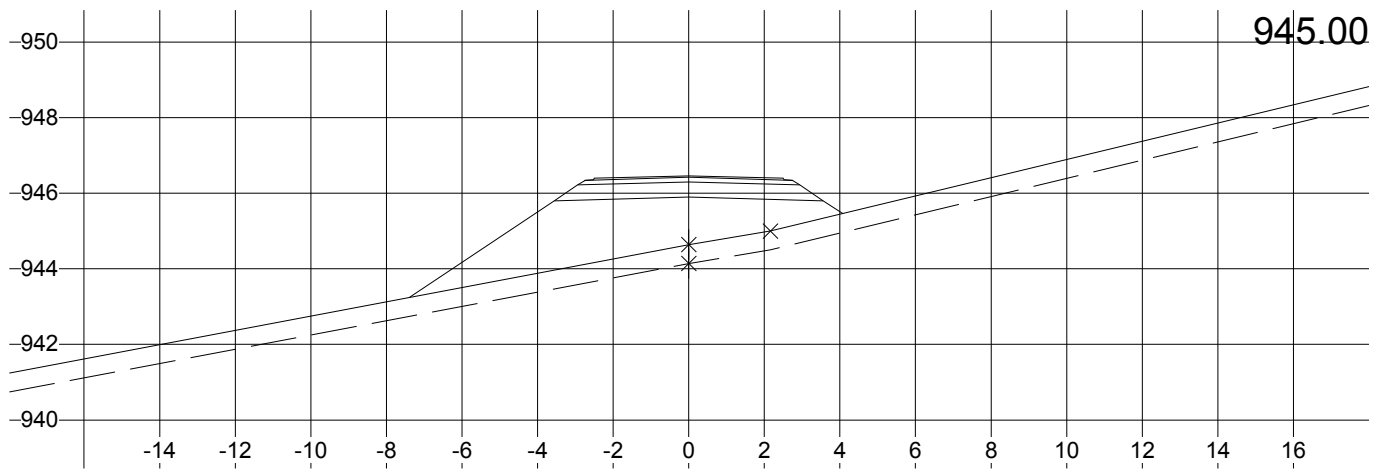

L:\IMA 4.7, Lisens: Plankontoret Hallvard Homme AS, Parsell: Parsell1, ps1

Rauland Invest AS Holtarvegen Tverrprofil	Tegnet av AST	Saksbehandler
	Sidemannskontr.	Prosjektansvarlig AST
	Dato 03.12.2009	Målestokk 1: 200
	Prosj.nr. 2219-v1	1: 200
Plankontoret H. Homme AS 4747 Valle Tlf: 37 93 70 00, Fax: 37 93 74 74, E-Post: post@plankontoret.no	Tegn.nr. -Tp-46	Rev.

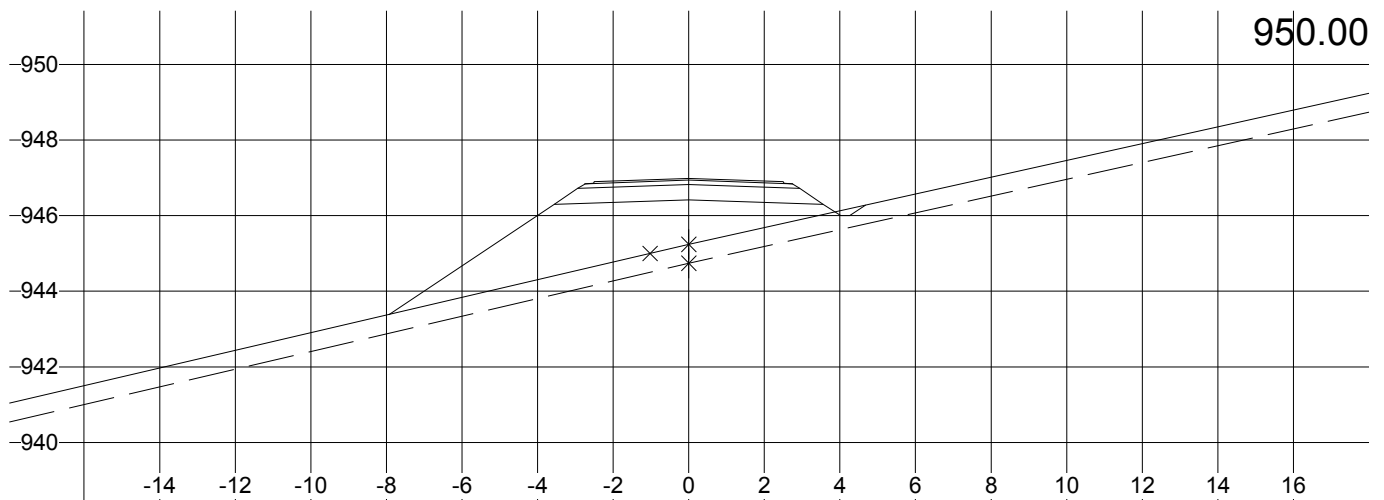
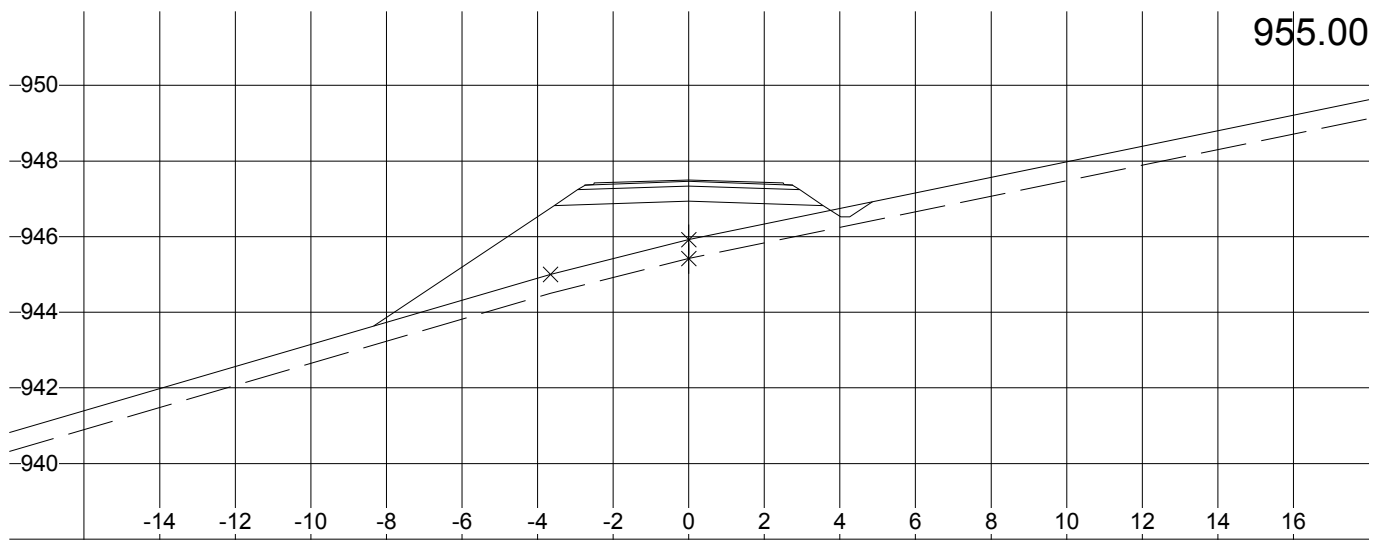
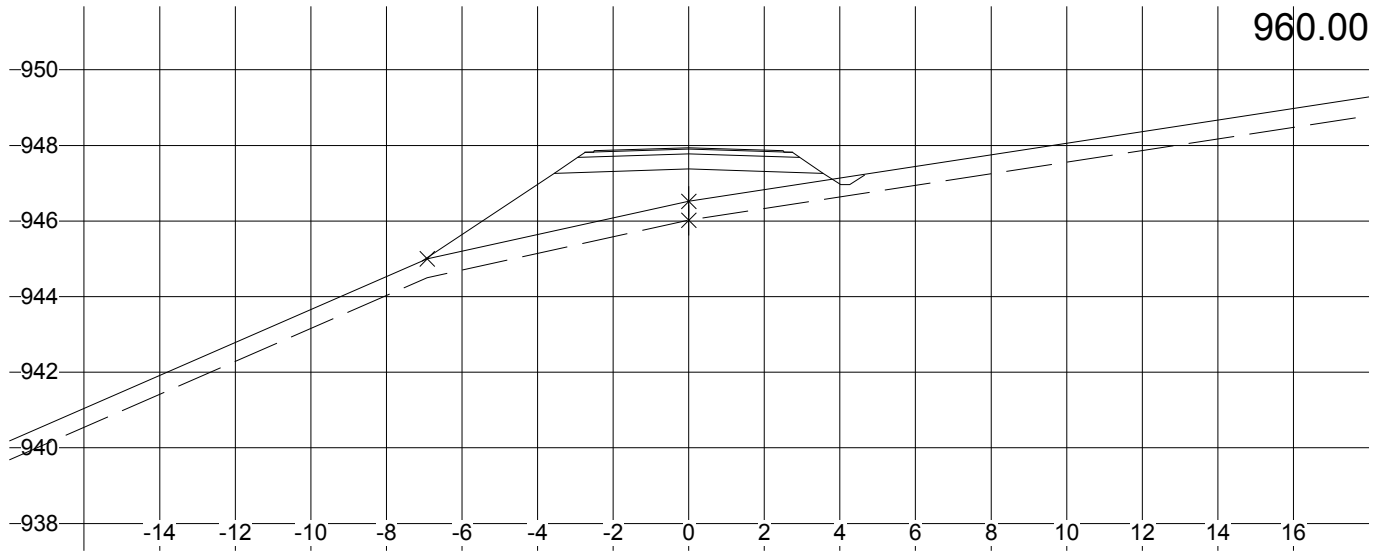

L:\IMA 4.7, Lisens: Plankontoret Hallvard Homme AS, Parsell: Parsell1.ps1

Rauland Invest AS Holtarvegen Tverrprofil	Tegnet av AST	Saksbehandler
	Sidemannskontr.	Prosjektansvarlig AST
	Dato 03.12.2009	Målestokk 1: 200 1: 200
	Prosj.nr. 2219-v1	Rev.
Plankontoret H. Homme AS 4747 Valle Tlf: 37 93 70 00, Fax: 37 93 74 74, E-Post: post@plankontoret.no	Tegn.nr. -Tp-47	

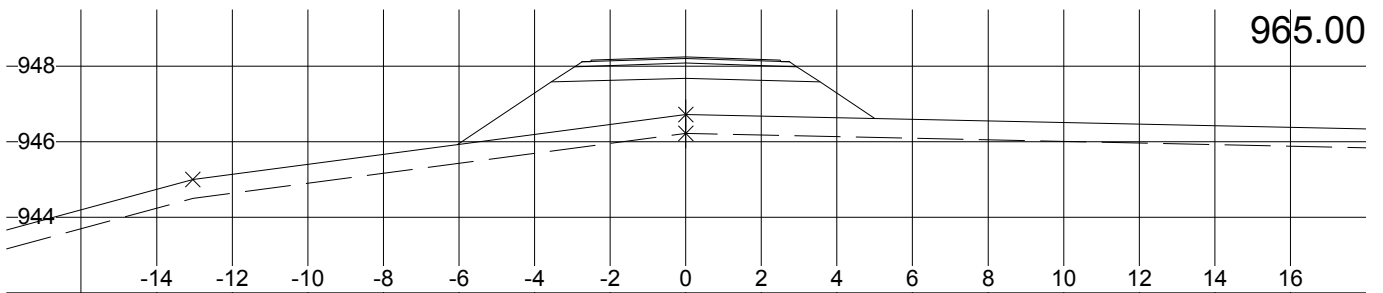
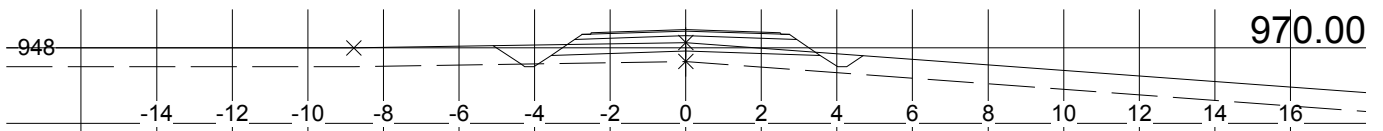
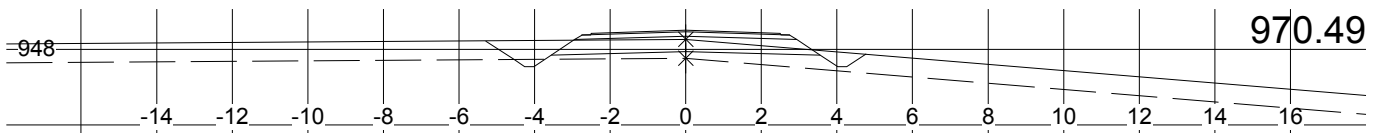

Rauland Invest AS Holtarvegen Tverrprofil	Tegnet av AST	Saksbehandler
	Sidemannskontr.	Prosjektansvarlig AST
Plankontoret H. Homme AS 4747 Valle Tlf: 37 93 70 00, Fax: 37 93 74 74, E-Post: post@plankontoret.no	Dato 03.12.2009	Målestokk 1: 200
	Prosj.nr. 2219-v1	1: 200
	Tegn.nr. -Tp-48	Rev.